

Electronic Servicing



A HOWARD W. SAMS PUBLICATION

Goodbye, TV Snow!



**Admiral Vertical Repairs
VIR Comparators
TV Towers**

PHILADELPHIA PA 19111
809 BERGEN ST
SAMUEL SACHS
E95-2074 R 1A 577 4

Don't Get Caught With Your MODULES DOWN

*Increase Your Profits By Utilizing
Our Module Rebuilding Program*

Consider these features!

- **Quality Parts**
We use original parts on all modules, no matter who the manufacturer is. Brands we rebuild include Admiral, GE, Magnavox, Montgomery Ward, Philco, Quasar, RCA, Sears/Warwick, Zenith and others.
- **Quality Workmanship**
Only professionally trained technicians rebuild modules at PTS. All modules are tested, temperature cycled, retested and airtested.
- **Protective Packaging**
Rebuilt modules are returned to you in polyethelene skin packaging for protection during shipping and storage.
- **Fast Service**
Quick, reliable service is our tradition.
- **One Year Warranty**
One year limited warranty on workmanship and parts.

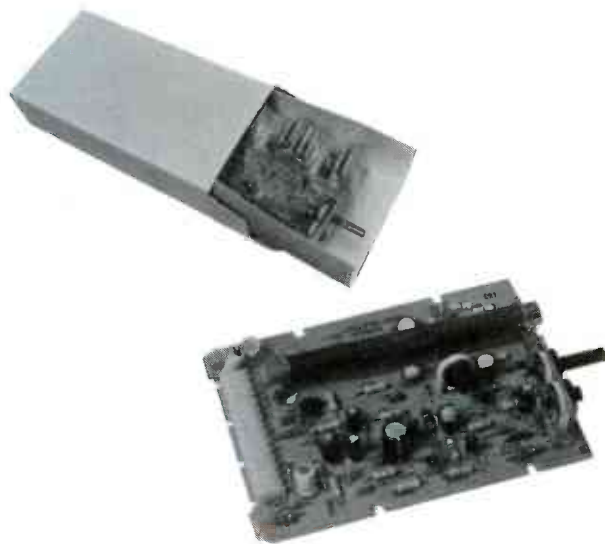

PTS ELECTRONICS, INC.
PRECISION TUNER SERVICE

P.O. Box 272 Bloomington, IN 47401 812-824-9331

THE COMPLETE LIST OF ALL PTS SERVICENTERS APPEARS ON THE NEXT PAGE.

For More Details Circle (25) on Reply Card

Electronic Servicing®

in this issue...

- 14 **Goodbye, TV Snow!**—Almost all snow can be eliminated by changing the analog video signal to digital. But there is a limitation—*David A. Ferré.*
- 24 **Servicing GE Modular Color TV, Part 9; Analyzing VIR Tint And Color Controllers**—In this conclusion of the GE coverage, we clarify the operation of the two controllers, and give preliminary troubleshooting advice—*Gill Grieshaber, CET.*
- 33 **Customer Talk**—Although it's primarily intended to give you a laugh, this story contains helpful truths—*Terry L. Turner.*
- 36 **The Physics Of Sound Applied To CB Radios**—Research produced the design of a speaker that makes CB messages more understandable—*Stephen R. Davis.*
- 40 **Troubleshooting Tips For Admiral Vertical**—Both practical tips and circuit operations are needed for servicing these new solid-state sweep systems—*Homer L. Davidson.*
- 48 **Towers...Rx For Fringe Areas**—Three things are essential for weak-signal TV reception, and extreme antenna height probably is the most important of these—*Bert Wolf.*
- 58 **Sequel to "The Trouble With Troubleshooting"**—Your replies to the article in the February issue have been compiled, plus some comments by the editor—*Carl Babcoke.*

ABOUT THE COVER

The only genuine comparison pictures, showing the noise-elimination advantage of digital video, no longer are available; and no digital video is being broadcast at this time. Therefore, these photos only simulate the amazing difference between analog and video snow.

DEPARTMENTS

Electronic Scanner	4	Service Associations	56
Troubleshooting Tips	8	Product Report	62
Symcure	10	Test Equipment	64
Reader's Exchange	11	Antenna Systems	65
Book Review	47	Audio Systems	66
Photofact	55	Catalogs and Literature	67
		Advertisers' Index	68

Second class postage paid at Shawnee Mission, Kansas and additional mailing offices. Published monthly at 9221 Quivira Road, Overland Park, Kansas 66212 by Intertec Publishing Corp., 9221 Quivira Road, Overland Park, Kansas 66212. Send Form 3579 to 9221 Quivira Road, P.O. Box 12901, Overland Park, Kansas 66212.

© Copyright, 1977, Howard W. Sams & Co., Inc. All rights reserved. Material may not be reproduced or photocopied in any form without written permission of publisher.

**YOU'VE GOT US
WHERE YOU
WANT US!**

**THE WORLD'S
LARGEST
TUNER SERVICE
IS CLOSE TO YOU!**

- | | |
|--|--|
| <p>MIDWEST</p> <p>Home Office
BLOOMINGTON, IN 47401
5233 S. Hwy. 37, P.O. 272
812-824-9331</p> <p>CLEVELAND, OH 44134
5682 State Road
216-845-4480</p> <p>KANSAS CITY, KS 66106
3116 Merriam Lane, P.O. 6149
913-831-1222</p> <p>MINNEAPOLIS, MN 55408
815 W. Lake St., P.O. 8458
612-824-2333</p> <p>ST. LOUIS, MO 63130
8456 Page Blvd., P.O. 24256
314-428-1299</p> <p>DETROIT, MI 48235
13707 W. 8 Mile Rd.
313-862-1783</p> <p>GRAND RAPIDS, MI 49501
1134 Walker Northwest
P.O. 1435
616-454-2754</p> <p>CINCINNATI, OH 45216
8172 Vine St., P.O. 15491
513-821-2298</p> <p>MILWAUKEE, WI 53218
7211 Fond du Lac
414-464-0789</p> <p>COLUMBUS, OH 43227
4005A E. Livingston
614-237-3820</p> <p>INDIANAPOLIS, IN 46202
28 E. 14th St.
317-631-1551</p> <p>DAVENPORT, IA 52805
2024 E. River Dr., P.O. 187
319-323-3975</p> <p>OMAHA, NE 68132
5008 Dodge Street
402-558-1800</p> <p>CHICAGO
Berkeley, IL 60163
1756 S. Taft Street
312-449-2082</p> <p>SOUTH</p> <p>ATLANTA, GA 30311
2180 Campbellton Road
P.O. 42558
404-753-0007</p> <p>JACKSONVILLE, FL 32210
1918 Blanding Blvd., P.O. 7923
904-389-9952</p> <p>WASHINGTON, DC
Silver Spring, MD 20910
8880 Brookville Rd.
301-565-0025</p> <p>CHARLOTTE, NC 28225
724 Seigle Ave., P.O. 5512
704-332-8007</p> <p>BIRMINGHAM, AL 35222
524-32nd St. So., P.O. 31004
205-323-2657</p> <p>MEMPHIS, TN 38118
3614 Lamar Ave., P.O. 18053
901-365-1918</p> <p>NORFOLK, VA 23504
3118 E. Princess Anne Rd.
804-625-2030</p> <p>NEW ORLEANS
Metairie, LA 70004
3920A Airline Hwy., P.O. 303
504-837-7569</p> <p>TAMPA, FL 33690
2703 S. Macdill, P.O. 14301
813-839-5521</p> <p>NASHVILLE, TN 37214
2426 A Lebanon Rd.
615-885-0688</p> | <p>NORTHEAST</p> <p>SPRINGFIELD, MA 01103
191 Chestnut, P.O. 3189
413-734-2737</p> <p>PHILADELPHIA
Upper Darby, PA 19082
1742-44 State Road
215-352-6609</p> <p>PITTSBURGH, PA 15202
257 Riverview Ave., P.O. 4130
412-761-7448</p> <p>E. PATERSON, NJ 07407
158 Market St., P.O. 357
201-791-6380</p> <p>BUFFALO, NY 14212
993 Sycamore St., P.O. 1241
716-891-4935</p> <p>BOSTON
Sommerville, MA 02144
52 Holland St., Davis Sq., P.O. 187
617-666-4770</p> <p>SYRACUSE, NY 13204
418 Solar St., P.O. 207, Salina Sta
315-475-2330</p> <p>BALTIMORE, MD 21215
5505 Reisterstown Rd.
301-358-1186</p> <p>PACIFIC</p> <p>SACRAMENTO, CA 95841
4611 Auburn Blvd., P.O. 41354
916-482-6220</p> <p>SAN DIEGO, CA 92105
5111 University Ave., P.O. 5794
619-280-7070</p> <p>LOS ANGELES, CA 90023
4184 Pacific Way
213-266-3728</p> <p>PORTLAND, OR 97213
5220 N.E. Sandy Blvd.
P.O. 13096
503-282-9636</p> <p>SEATTLE, WA 98109
432 Yale Ave. N., P.O. 9225
206-623-2320</p> <p>MOUNTAIN</p> <p>DENVER
Arvada, CO 80001
4958 Allison St., P.O. 672
303-423-7080</p> <p>SALT LAKE CITY, UT 84106
1233 Wilmington Ave.
P.O. 6218
801-484-1451</p> <p>PHOENIX, AZ 85061
2412 W. Indian School Rd.,
P.O. 27248
602-266-0582</p> <p>SOUTHWEST</p> <p>LONGVIEW, TX 75601
Mapac Rd., P.O. 7332
214-753-4334</p> <p>OKLAHOMA CITY, OK 73106
3007 N. May, P.O. 60566
405-947-2013</p> <p>HOUSTON, TX 77207
4326 Telephone Rd., P.O. 26616
713-644-6793</p> <p>CANADA</p> <p>MONTREAL, QUEBEC H2 P2 M4
8400 St. Laurent Blvd., Room 205
514-381-5838</p> |
|--|--|



PTS ELECTRONICS, INC.
PRECISION TUNER SERVICE

For More Details Circle (1) on Reply Card

MEET OUR family of ELECTRONIC TEST ACCESSORIES



The 1977 edition of our family album of electronic test accessories (illustrated above) is yours for the asking.

Our new general catalog has grown to 82 pages. It describes and illustrates every one of the 600-plus members of the ITT Pomona Electronics family, including 28 new items that have been added for the first time this year.

You'll find this comprehensive catalog will be your best single source for high quality test accessories in every phase of electronic testing. For your free copy, circle the reader service number listed below, or write:

ITT POMONA ELECTRONICS

1500 East Ninth St., Pomona, Calif. 91766
Telephone (714) 623-3463, TWX: 910-581-3822



For More Details Circle (2) on Reply Card

Electronic Servicing

Editorial, advertising and circulation correspondence should be addressed to: 9221 Quivira Road, P.O. Box 12901, Overland Park, Kansas 66212 (a suburb of Kansas City, Missouri). (913) 888-4664.

EDITORIAL

RONALD N. MERRELL, Director

CARL H. BABCOKE, Editor

MICHAEL SCHEIBACH, Editorial Assistant

DUDLEY ROSE, Graphic Designer

EDITORIAL ADVISORY BOARD

LES NELSON, Chairman
Howard W. Sams & Co., Indianapolis

JOE A. GROVES, Technical Consultant
Howard W. Sams & Co., Indianapolis

CIRCULATION

GREG GARRISON, Director

EVELYN ROGERS, Manager



Member, American Business Press
Member, Audit Bureau of Circulations

ADMINISTRATION

GEORGE H. SEFEROVICH, President

MIKE KREITER, Publisher

ADVERTISING SALES

Overland Park, Kansas 66212
(a suburb of Kansas City, Missouri)
Phone: (913) 888-4664

GLORIA PARMENTER, Production
Regional and Advertising Sales Offices
with Advertising Index

ELECTRONIC SERVICING (with which is combined PF Reporter) is published monthly by Intertec Publishing Corp., 9221 Quivira Road, Overland Park, KS 66212.

ELECTRONIC SERVICING is edited for technicians who repair home-entertainment electronic equipment (such as TV, radio, tape, stereo, and record player), and for industrial technicians who repair defective production-line merchandise, test equipment, or industrial controls in factories.

Subscription Prices: 1 year—\$6.00, 2 years—\$10.00, 3 years—\$13.00, in the U.S.A. and its possessions. All other foreign countries: 1 year—\$7.00, 2 years—\$12.00, 3 years—\$16.00. Single copy 75 cents; back copies \$1. Adjustment necessitated by subscription termination to single copy rate. Allow 4-6 weeks delivery for change of address. Allow 2-3 weeks for new subscriptions.



INTERTEC PUBLISHING CORP.
Subsidiary of HOWARD W. SAMS & CO., INC.

ELECTRONIC SERVICING

A GOOD FUSE CAN'T HOLD ON WITHOUT A GOOD GRIP.



GET BOTH FROM BUSSMANN.

Don't put a good fuse in the grip of a poor fuse holder. If the holder can't hold on right, the best fuse in the world can't, either.

Some clips just don't have the muscle to hold tight. The fuse gets loose. The heat builds up. You know what happens.

There's an easy way to put a stop to it: Put good Buss fuses in good Buss fuse holders. Our holders are made with the muscle it takes to keep a good tight grip on trouble-free electronics protection.

They'll pay off for you a thousand times over in reliability that's for sure, not for maybe.

Your equipment deserves the best. Bussmann has it for you. A great fuse. And a great grip. Get them together now.

Ask for Buss Bulletin SFB.

SUPPLYING THE ECONOMICAL WAY
THRU DISTRIBUTORS
BUSS FUSES
THE QUALITY LINE



BUSSMANN MANUFACTURING
a McGraw-Edison Company Division
Earth City, Missouri 63045

electronicscanner

news of the industry

John Borlaug, National Service Manager for GTE Sylvania, was named "Time/NARDA Man of the Year" at the NARDA National Convention held recently in Atlanta, Georgia. The award is presented annually by Time magazine, and the recipient is selected by the board of directors of the National Association of Retail Dealers of America (NARDA). As chairman of the Electronic Industries Association sub-committee on warranty in 1976, Borlaug helped bring about industry-wide agreement on a common warranty form.

RCA has entered into a licensing agreement to manufacture a circularly-polarized antenna developed by the Jampro Antenna Company. This is in anticipation of the FCC's expected approval of CP antennas as an alternate method of broadcasting television. The new CP antenna transmits the TV signal in both vertical and horizontal planes, with significant reductions in "snow" and "ghosts". (The November 1975 issue of Electronic Servicing discussed the test results of circular polarization of TV antennas.)

The California State Legislature has voted to amend Senate Bill 159 and Assembly Bill 236 to allow the use of fluorocarbons in tuner sprays and chillers. The legislature took the action following testimony by Harry Midkiff, executive director of the California State Electronics Association, who told legislative committee members that F-11 and F-13 are important cleaning agents for tuners, controls, and switches, and F-12 helps pinpoint faults in circuitry. He estimated that it could cost Californians an additional \$250 million if each tuner had to be taken apart and cleaned by hand. Midkiff also told legislators that the electronics industry as a whole utilized only about 2200 tons of fluorocarbons, out of the 557,000 tons used worldwide.

The total number of CB licenses for the first quarter of 1977 is expected to reach 2.2 million, bringing the number of licensed Cbers in the United States to about nine million. The FCC has announced that 678,330 CB licenses were granted in February—a record number—and that final totals for March and April may exceed 1½ million.

The FCC's existing regulation of pay cable television is in violation of the First Amendment, and is therefore unconstitutional and improper, the U.S. Court of Appeals for the District of Columbia has ruled. Pay cable television now is prohibited from showing certain sports events, feature films, and series programs. The New York Times reported that federal restrictions must be ended because the FCC has exceeded its authority, and because evidence supporting regulation of cable TV is lacking. The decision may result in open competition between the major networks and pay cable television for rights to sports events and first-run movies.

continued on page 5

In replacement parts nothing is foreign to us.

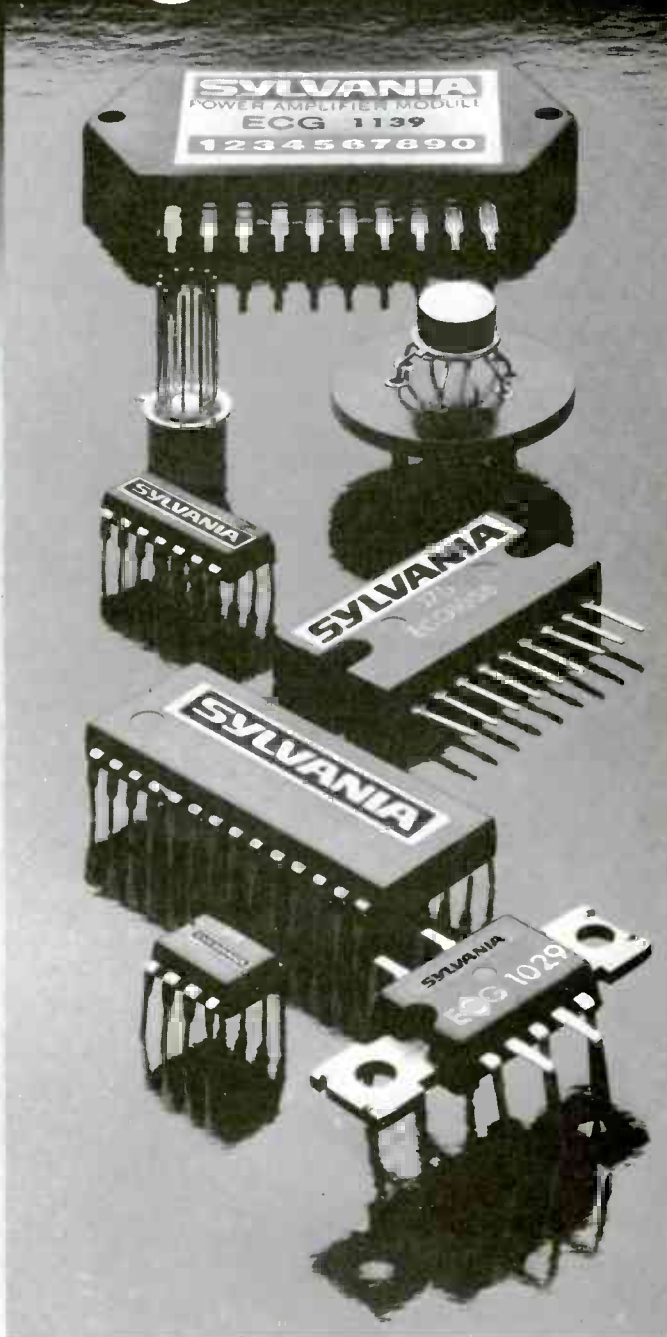
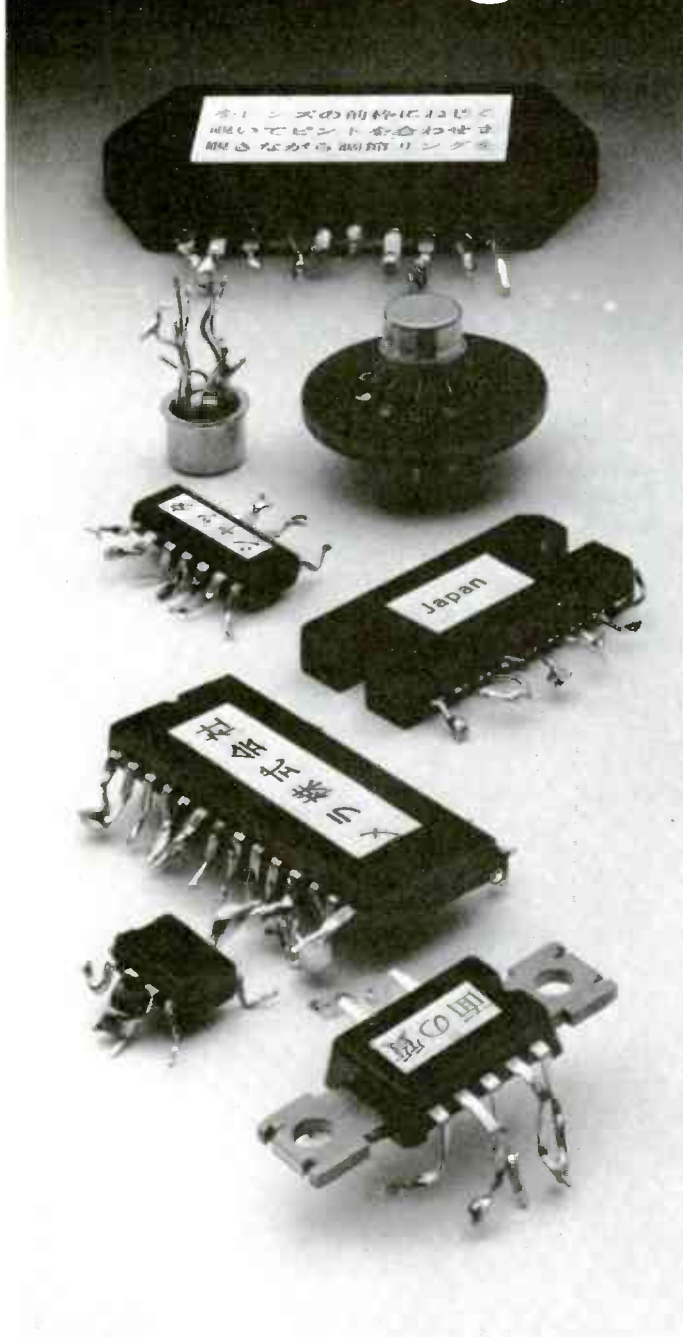

We know the problems in finding the right semiconductor replacements for imported TV, CB and other electronic equipment.

That's why we have a line of thick-film modules and ICs that will replace over 3,000 devices in 139 brands of foreign-made equipment.

And we've made them easy to find in two ways. One is through our new Module and IC Replacement Guide that cross references the original part number with

our ECG® semiconductor part number.

The other way we've made it easy is by making sure your local Sylvania distributor has access to a full stock of semiconductor replacements.

Pick up a copy of the replacement guide at your distributor today, so you'll be able to pick up all the parts you need in just one stop tomorrow.

GTE SYLVANIA

continued from page 4

CB sales can be expected to grow at least 30% by 1980, reaching \$1.3 billion annually, according to an impact assessment of the industry's outlook compiled by Arthur D. Little, Inc. The ADL study concluded that the forces contributing to past growth are still operating in the marketplace: reduced licensing fees, and simplified licensing procedures; wider availability in general merchandise retail outlets; aggressive merchandising; and CB radio clubs. In addition, CB's usefulness in public safety, the increasing number of CB automobile options, and a greater number of replacement purchases should contribute to a boom market for CBs in the future.

Two "con" men in Florida have been posing as FCC inspectors, entering homes by showing fake badges and papers, and threatening to confiscate "improper" CB-radio equipment, reports *Retailing Home Furnishings*. Then, they offer to settle each case if the operator pays a fine. They have received amounts of cash from \$50 to \$1,000. CB owners should be told that federal officers cannot assess or collect any fines in person, fines or citations for improper CB equipment or operations always are sent through the mail, and a court order is necessary for impoundment of equipment. The FBI is investigating the incidents.

Hughes Aircraft Company has developed a jam-resistant radio terminal that will enable aircraft surveillance and the command center to relay information over a single network on a time-ordered basis. The Time Division Multiple Access (TDMA) radio terminal uses spectrum spreading, frequency hopping, and error correction for jam resistance. It is being built by Boeing for use in the Air Force's E-3A airborne warning and control-system aircraft.

A videotape recorder made by Matsushita Electric Industrial Company will be marketed in the U.S. by RCA, *Electronic News* has reported. The Matsushita VTR, available this summer, features a changeable 2- and 4-hour cassette, VHF and UHF tuners, and a clock for automatic recording. Optional equipment includes microphones and cameras for consumers to produce home movies on VTR cassettes. RCA is still developing a video disc player which it plans to introduce in 1978. Because of price differences between the VTR and video disc player, however, RCA does not expect the two product lines to compete in the marketplace.

The Customs Court in New York has upheld Zenith's petition that TV sets and other consumer electronics products imported from Japan should be subject to countervailing import duties. Zenith had alleged that subsidies provided by the government of Japan allowed Japanese manufacturers to "dump" their products into the United States at prices below those in Japan. In addition, the government had forgiven or rebated commodity taxes on all television receivers exported to this country. The Customs Court ruled that the remission of these commodity taxes, permitting Japanese manufacturers to sell below U.S. prices, constitutes a subsidy. Therefore, these products now will be subject to countervailing duties.

TUNER SERVICE CORPORATION

SUBSTITUNER



JUST

\$49⁹⁵

U.S.A. ONLY

WITH CABLES

ONE YEAR GUARANTEE



\$10⁹⁵

U.S.A. ONLY

MAJOR PARTS AND SHIPPING CHARGES AT COST

FEATURES

- A UHF Tuner with 70 channels which are detented and indicated just like VHF channels.
- A VHF Hi Gain Solid-State Tuner
- AC Powered
- 90-Day Warranty

Demonstrate the **SUBSTITUNER** to your customers and show improved reception with their TV sets.

You may place your order through any of the Centers listed below.

FLASH!

NOW AVAILABLE — TUNER SERVICE PARTS CATALOG OF ALL SARKES TARIAN VHF AND UHF TUNERS, INCLUDING EXPLODED VIEW DRAWINGS. OVER 200 PAGES. ORDER YOUR COPY TODAY. SEND \$2.50 WITH ORDER TO BLOOMINGTON HEAD OFFICE.

PROVIDES YOU WITH A COMPLETE SERVICE FOR ALL YOUR TELEVISION TUNER REQUIREMENTS.

TUNER REPAIRS

VHF OR UHF ANY TYPE (U.S.A.) \$10.95
 UHF/VHF COMBINATION (U.S.A.) \$17.95

MAJOR PARTS AND SHIPPING CHARGED AT COST

FAST, EFFICIENT SERVICE AT ANY OF THE CONVENIENTLY LOCATED SERVICE CENTERS LISTED BELOW.

ONLY ORIGINAL FACTORY PARTS USED

All tuners ultrasonically cleaned, repaired and realigned.

EXACT REPLACEMENT

Exact Replacement Tuners are available at a cost of \$14.95 and up. (U.S.A. Only)
 Send in your original tuner for comparison purposes to any of the Centers listed below.

UNIVERSAL REPLACEMENT

UNIVERSAL REPLACEMENT TUNER \$13.95 (U.S.A. Only)

This price buys you a complete new tuner built specifically for this purpose.

All shafts have a maximum length of 10 1/2" which can be cut to 1 1/2".

Specify heater type parallel and series 450 mA or 600 mA.



HEADQUARTERS	BLOOMINGTON, INDIANA 47401	537 South Walnut Street	Tel. 812-334-0411
ALABAMA	BIRMINGHAM, ALABAMA 35212	5623 1st Avenue North	Tel. 205-592-9150
CALIFORNIA	NORTH HOLLYWOOD, CALIF. 91601	10654 Magnolia Boulevard	Tel. 213-759-2720
	SAN MATEO, CALIF. 94402	600 S. Amphlett Blvd.	Tel. 415-348-3292
	MODESTO, CALIF. 95351	123 Phoenix Avenue	Tel. 209-521-8051
FLORIDA	TAMPA, FLORIDA 33605	1505 Cypress Street	Tel. 813-253-0324
	FT. LAUDERDALE, FLORIDA 33309	3516 N.W. 10th Ave.	Tel. 305-566-8882
GEORGIA	ATLANTA, GA. 30810	646 Evans St. S.W.	Tel. 404-754-2232
ILLINOIS	URBANA, ILLINOIS 61801	908 E. Main Street	Tel. 217-564-2052
	SKOKIE, ILLINOIS 60076	5110 West Brown Street	Tel. 312-675-0230
INDIANA	INDIANAPOLIS, INDIANA 46204	112 West St. Clair Street	Tel. 317-632-3493
KENTUCKY	LOUISVILLE, KENTUCKY 40205	2244 Taylorsville Road	Tel. 606-452-1191
LOUISIANA	MONROE, LOUISIANA 71104	2423 Southern Avenue	Tel. 318-221-3027
MASSACHUSETTS	SPRINGFIELD, MASS. 01108	405 Dickinson St.	Tel. 413-788-8206
MISSOURI	ST. LOUIS, MISSOURI 63132	9577 Page Avenue	Tel. 314-429-0633
NEVADA	LAS VEGAS, NEVADA 89102	1412 Western Avenue	Tel. 702-384-4235
NEW JERSEY	TRENTON, NEW JERSEY 08638	1139 Pennsylvania Ave.	Tel. 609-393-0999
	JERSEY CITY, NEW JERSEY 07307	454 Central Ave.	Tel. 201-792-3730
NEW YORK	ROCHESTER, NEW YORK 14615	37 Pullman Ave.	Tel. 716-647-9180
N. CAROLINA	GREENSBORO, N.C. 27405	2914 E. Market Street	Tel. 919-273-6276
OHIO	CLEVELAND, OHIO 44109	4525 Pearl Road	Tel. 216-741-2314
OREGON	PORTLAND, OREGON 97249	1732 N.W. 25th Ave., P.O. Box 10141	Tel. 503-222-9059
PENNSYLVANIA	PITTSBURGH, PA. 15209	515 Grant Avenue	Tel. 412-821-4004
TENNESSEE	MEMPHIS, TENNESSEE 38111	3158 Barron Avenue	Tel. 901-458-2355
TEXAS	DALLAS, TEXAS 75218	11540 Garland Road	Tel. 214-327-8413
CANADA	ST. LAURENT, QUEBEC H4N-2L7	385 DeMarie Boulevard	Tel. 514-748-8803
	CALGARY, ALBERTA T2H-1Y3	P.O. Box 5823, Stn. "A"	Tel. 403-243-0971

WATCH US GROW

If you want to branch out into the TV Tuner Repair Business write to the Bloomington Headquarters about a franchise.

For More Details Circle (4) on Reply Card

FAST

COMPLETE SERVICE ON ALL MAKES OF TV TUNERS

Maximum Time In Shop 24 Hrs.

(Warranty: One Full Year)

(WE SHIP C.O.D.)
YOU PAY SHIPPING
\$10.95

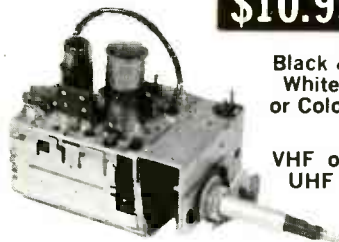

Black & White or Color

VHF or UHF

UV Combo's \$17.95

Price includes all labor and parts except Tubes, Diodes & Transistors. If combo tuner needs only one unit repaired, disassemble and ship only defective unit. Otherwise there will be a charge for a combo tuner. When sending tuners for repair, remove mounting brackets, knobs, indicator dials, remote fine tuning arrangements and remote control drive units.

WE UNCONDITIONALLY GUARANTEE All Tuners FOR ONE FULL YEAR



All tuners are serviced by EXPERTLY TRAINED TECHNICIANS with years of experience in this specialized field. All tuners are ALIGNED TO MANUFACTURER'S SPECIFICATION on crystal controlled equipment and air checked on monitor before shipping to assure that tuner is operating properly.

GEM CITY TUNER SERVICE

Box 6G Dabel Station
1621 Mardon Drive
Dayton, Ohio 45420

troubleshootingtips

Send in your helpful tips—we pay!

Small picture Admiral 4M10C chassis (Photofact 1504-1)

Sound and color were both okay, but the picture was about half size, both horizontally and vertically. Another firm had worked on it previously, replacing the focus divider network.

I removed the back and made a careful visual inspection. Nothing was apparently wrong, so I checked all of the power supply voltages. They were all low, and the +125-volt supply measured only +82 volts.

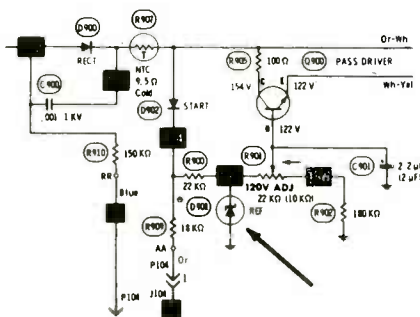

Next, the "pass" transistors were checked in-circuit by the method suggested by Admiral, and they seemed to be normal. The 120 VAC input to the 120-volt supply was all right, as was the DC from D900. There was no excessive drop across R907 and D902.

Only the voltage at the cathode of zener diode D901 was wrong. It should have been +125 and instead it measured +82 volts. All of the resistors in that circuit were within tolerance. Finally, I removed D901 from the chassis and discovered that it measured about 6 megohms of reverse leakage (should have exceeded 200 megohms).

Well, 6 megohms is not much of a short, but I replaced D901 and the receiver produced a full-sized picture.

Vaughn Deem
Ogden, Utah

Horizontal output failure Penncrest Model 2124 (made by GE— Photofact 1471-1)

This receiver is the same as a Chassis 19QB by General Electric. Suppose the horizontal-output transistor fails and the overload blows fuse F404. If you merely install a new transistor and fuse, the new transistor might fail immediately the next time power is applied. Some test is needed that permits powered operation without ruining more transistors.

Try this method. Replace all known bad parts, except F404. **Connect a 100-watt conventional incandescent light bulb in parallel with the open fuse. Excessive current will light the bulb, giving a visual indication of an overload, and also reduce the voltage that reaches the transistor, thus preventing a second failure of the transistor.**

Apply power to the TV, advance the brightness and screen controls, and attempt to obtain a raster. If a nearly-full raster is seen, then probably you have replaced the defective parts, and it is safe to restore full power. Remember, the light bulb should glow dimly when the set has full brightness.

However, if the bulb glows more brightly, a defect still remains in the horizontal-output stage. Check all of the scan rectifier B+ supplies for shorts or overloads, particularly the 200-volt supply. For example, if the voltage is less than +160, diode Y214 probably is breaking down under load, and in turn loading down Q206, the output. **Don't use conventional 60-Hz diodes; because Y214 is a fast-recovery type. This warning applies to all scan-rectifier circuits.**

Of course, this method with the light bulb can be used with many other solid-state TV's.

L. R. Luchi, CET
Kennewick, Washington

Intermittent locking RCA CTC55XP (Photofact 1203-2)

The complaint on this RCA CTC55 was a loss of both vertical

and horizontal locking after about 20 minutes of operation.

I unsoldered the PW500 circuit board, and replaced the horizontal phase-detector dual-diode. Unfortunately, after the usual 20 minutes, the sync was lost again.

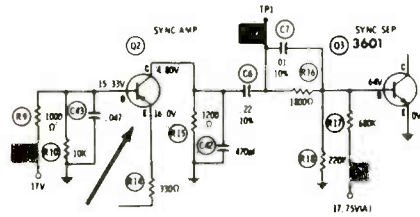

Next, I checked all components of the sync circuit, and even tried another phase-detector unit, but with no improvement. When I was about ready to give up for that day, I pulled the power plug and checked Q2 again while it was warm. This is the sync transistor, and it had an **open** B/C junction. Now the intermittent was cured.

John Lombardi
Bradford, Pennsylvania

Editor's Note: Giving advice after the trouble's cured is not fair, but it seems likely the heating-and-cooling technique might have been the best bet here. The suspected parts are heated (perhaps with a heat source with a small spout to direct the heat) one at a time. After the set malfunctions, carefully spray canned coolant on each part. Spray gently, and cool only one component at a time. Repeat the test again for best accuracy. There are cases where this technique is the best of all.

Got A Troubleshooting Tip?

If you've recently run across an unusual trouble symptom, send a thorough description of it and the solution to:

**Troubleshooting Tips
Electronic Servicing
P.O. Box 12901
Overland Park, Kansas 66212**



Seeking Original Japanese Replacement Parts for CB Repair Use?

CB REPAIR PACKAGE \$77.00 value for only \$59.00				SPECIAL PACKAGE OF MOST COMMON DRIVERS & FINALS			
<i>Now repair almost all CB's with this package of Japanese Transistors</i>				<i>This kit contains 6 each of:</i>			
2SK 19 FET	2 pcs	ZSC 1306	4 pcs	ZSC 775	ZSC 756	ZSC 799	
ZSD 235	4 pcs	ZSC 1239	3 pcs	ZSC 1018	ZSC 799	ZSC 1239	
ZSC 710	10 pcs	ZSC 1307	4 pcs	ZSC 1226	ZSC 1239	ZSC 1307	
ZSC 775	4 pcs	ZSC 756	3 pcs	ZSC 1306	ZSC 1307		
				\$140.00 value for Just \$99.95			

CHECK OUR NEW REDUCED PRICES!

Original Japanese Transistors, FET, IC, Diodes

TRANSISTORS										FET		DIODES			
ZSA 495	70	ZSB 463	1.50	ZSC 509	90	ZSC 776	2.65	ZSC 1060	2.25	ZSC 1675	1.55	ZSK 19	1.60	TA 7061AP	1.90
ZSA 562	59	ZSB 471	1.60	ZSC 517	3.95	ZSC 777	3.50	ZSC 1061	1.40	ZSC 1678	2.25	ZSK 30	.90	TA 7206P	3.90
ZSA 628	59	ZSB 474	1.20	ZSC 535	70	ZSC 778	3.60	ZSC 1096	1.00	ZSC 1679	4.25	ZSK 33	1.10	BA 511	3.40
ZSA 634	59	ZSB 492	1.20	ZSC 536	59	ZSC 781	2.65	ZSC 1166	59	ZSC 1684	59	ZSK 34	1.10	BA 521	3.70
ZSA 640	90	ZSB 493	1.20	ZSC 562	2.15	ZSC 784	59	ZSC 1173	90	ZSC 1728	2.00	ZSK 34	1.10		
ZSA 643	70	ZSB 494	1.20	ZSC 583	59	ZSC 785	70	ZSC 1175	90	ZSC 1760	2.00	ZSK 47	1.20		
ZSA 683	70	ZSB 518	1.20	ZSC 620	59	ZSC 789	1.00	ZSC 1189	1.40	ZSC 1816	4.25	ZSK 49	1.30		
ZSA 719	70	ZSB 520	1.20	ZSC 668	59	ZSC 793	2.15	ZSC 1213	70	ZSC 1908	59	ZSK 55	1.30	IS 84	1.00
ZSA 720	70	ZSB 521	1.20	ZSC 696	1.95	ZSC 799	3.60	ZSC 1226	1.00	ZSC 1909	4.40	ZSK 68	1.30	IS 188	45
ZSA 721	70	ZSB 522	1.20	ZSC 710	59	ZSC 802	3.60	ZSC 1237	4.25	ZSC 1957	1.20	ZSK 68	1.30	IS 332	45
ZSA 727	70	ZSB 523	1.20	ZSC 711	59	ZSC 815	59	ZSC 1239	3.50	ZSC 1975	4.40	ZSK 22GR	2.55	IS 953	45
ZSA 733	59	ZSB 524	1.20	ZSC 712	59	ZSC 828	59	ZSC 1306	4.40	ZSD 77	1.00	ZSK 35	2.25	IS 1007	45
ZSB 54	59	ZSC 387	59	ZSC 717	59	ZSC 829	59	ZSC 1307	4.90	ZSD 142	2.00	ZSK 39	2.25	IS 1209	45
ZSB 75	59	ZSC 394	59	ZSC 732	59	ZSC 838	59	ZSC 1317	59	ZSD 180	2.50	ZSK 41	2.50	IS 1211	45
ZSB 77	59	ZSC 403	59	ZSC 733	59	ZSC 839	59	ZSC 1318	59	ZSD 187	66	ZSK 45	2.50	IS 1555	32
ZSB 186	59	ZSC 454	59	ZSC 734	59	ZSC 900	59	ZSC 1330	1.50	ZSD 188	3.00	MK 10	2.00	IS 1588	32
ZSB 324	70	ZSC 458	59	ZSC 735	59	ZSC 930	59	ZSC 1359	1.40	ZSD 227	59			IS 1885	45
ZSB 337	1.60	ZSC 460	59	ZSC 756	2.80	ZSC 943	1.20	ZSC 1364	1.40	ZSD 234	1.00			IS 2076	45
ZSB 367	1.50	ZSC 461	59	ZSC 763	59	ZSC 945	59	ZSC 1377	4.90	ZSD 235	1.00			IS 2093	45
ZSB 368	2.15	ZSC 482	1.50	ZSC 773	70	ZSC 1014	1.20	ZSC 1449	1.00	ZSD 313	1.10	SN 7400	19	IS 2473	45
ZSB 405	70	ZSC 482	1.50	ZSC 774	1.60	ZSC 1017	1.40	ZSC 1475	1.40	ZSD 325	1.10	SN 7490	60	IN 60	25
		ZSC 495	1.00	ZSC 775	1.95	ZSC 1018	1.20	ZSC 1674	1.55	ZSD 360	1.20	TA 7045M	3.00	IN 30	25

PRICES MAY CHANGE WITHOUT NOTICE

IMMEDIATE DELIVERY WITHIN 48 HOURS
ON ALL TRANSISTORS IN STOCK

Minimum order \$10.00. Ohio residents add 4% sales tax.
Add \$1.00 postage and handling. Quantity discount prices.

ASK FOR OUR COMPLETE PRICE LIST
MANUFACTURER INQUIRIES WELCOMED

All Parts Guaranteed Against Factory Defects

FUJI-SVEA ENTERPRISE

Dept. CB Marketing
P.O. Box 40325
Cincinnati, OH 45240
(513) 874-0220

For More Details Circle (6) on Reply Card

Patents Pending
covering 13 unique features.



ATC-10

GENERAL TELEVISION SERVICER

YOUR PORTABLE, COST EFFECTIVE SOURCE OF A CONVENTIONAL COLOR BAR PATTERN GENERATOR, A SUBSTITUTE TUNER AND MOST USED FUNCTIONS OF AN ANALYST, PLUS:

- RF/IF attenuator capable of reducing the signal to snow for receiver sensitivity.
- GRAY QUAD pattern for simplified gray scale tracking checks/adjustments.
- COLOR BARS pattern with 6th bar marked to make your job easier.
- 3.58 MONITOR pattern for oscillator frequency checks with no need to short the AFPC test point.
- RED RASTER pattern for checking and adjusting purity at the flip of a switch.
- HATCHDOTS - versatile composite pattern for dynamic & static convergence plus other checks.
- High level 75 ohm video output.

ALL THIS FOR ONLY \$299.95!



Carl Babcoke (Electronic Servicing) says . . .

"If I could choose only one of the many kinds of dot or crosshatch patterns, I would want this one."

Think how much easier the composite HATCHDOTS pattern (left) would make *your* job. It can also perform size, linearity, pincushion and centering checks. It's only one of several unique patterns produced by the ATC-10 that can save you time, trouble and most important — money!

Write for more information on the ATC-10 General Television Servicer, or try it at our risk.

—30 DAY SHOP TRIAL—

(If not 100% satisfied in every way, return for instant refund in full.)

American Technology Corporation

225 Main Street, Dept. 5A
Canon City, CO 81212

For your convenience, we accept Master Charge, Visa and COD phone orders.

Same day shipment!
(303) 275-8991

For More Details Circle (7) on Reply Card

Chassis—Zenith 25DC56
PHOTOFACT—1312-3

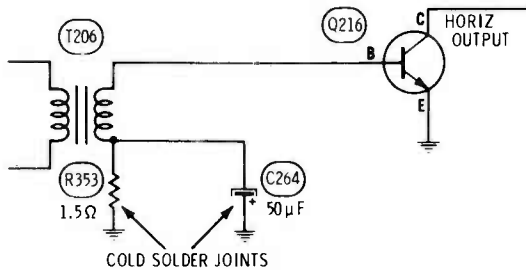

Symptom—Intermittent narrow width with center foldover
Cure—Check for a bad solder joint at the ground for R353 and C254

Chassis—Zenith 25DC56
PHOTOFACT—1312-3

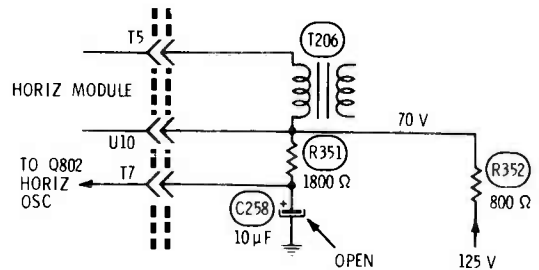

Symptom—No high voltage or 240 V supply
Cure—Check capacitor C258, and replace it if open

Chassis—Zenith 25DC56
PHOTOFACT—1312-3

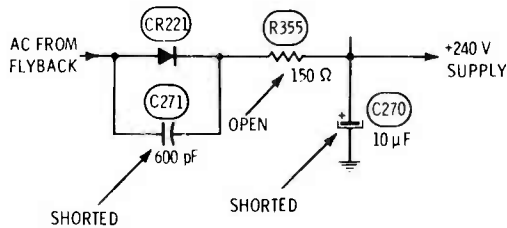

Symptom—No control of brightness; screens won't adjust
Cure—Check C271 and C270; if shorted might have burned R355

Chassis—Zenith 25GC50
PHOTOFACT—1554-2

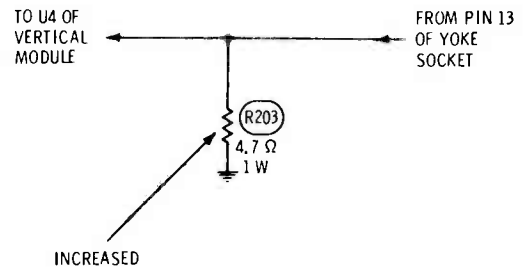

Symptom—Insufficient height
Cure—Check R203, and replace if it has increased in resistance

Chassis—Zenith 25GC50
PHOTOFACT—1554-2

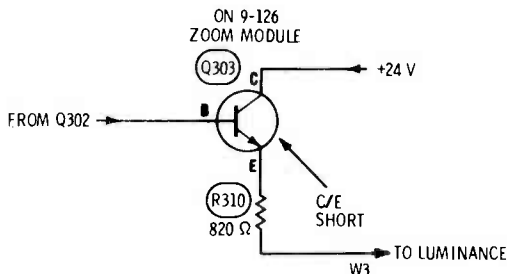

Symptom—Insufficient brightness
Cure—Check Q303 on the zoom module, and replace it if shorted

Chassis—Zenith 13GC10
PHOTOFACT—1540-2

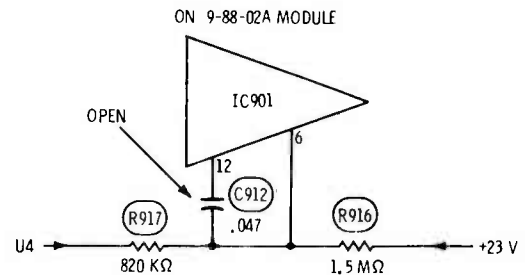

Symptom—Left half of raster is black with three white vertical bars; right half is blacker
Cure—Check capacitor C912 on module 9-88, and replace if open

reader's exchange

There is no charge for listing in *Reader's Exchange*, but we reserve the right to edit all copy. If you can help with a request, write direct to the reader, not to *Electronic Servicing*.

Needed: Service data for a Minshall-Estey organ Model 397, serial H1893. Also, parts for an Everett old reed-type organ (model unknown). *Osceola Electronics, 226 South M66 Highway, Marion, Michigan 49665.*

Needed: Source of replacement parts for a Muntz stereo 8-track auto-tape player—particularly a solenoid number ESR-5. *Bernard Grupe, Bernard Radio & Tape Player Service, 3012 Highland Drive, Cary, Illinois 60013.*

Needed: Schematic for a Monarch Model SAT-260X stereo receiver. Will buy or copy and return. *Norman S. Hurley, Burg Electronics Service, 1700-28th Avenue, South, Birmingham, Alabama 35209.*

For Sale: B&K Model 1076 analyst with manual, \$175 including delivery. Also, Sencore Model SM158 sweep-marker generator, with BE156 bias box and manuals, \$175 including UPS. All three in like-new condition. *Glenn Wise, Wise Radio & TV Service, P.O. Box 152, Irvine, Kentucky 40336.*

Needed: Rider's radio manuals 1 through 5, or will buy whole set to get these five. *D. Swindal, 1112 San Jose Lane, Hanahan, South Carolina 29406.*

Needed: BK-29D ballast tube for Hallicrafters Sky rider marine radio receiver. *Scott Fecsen, 981 Wilson Street, Charleroi, Pennsylvania 15022.*

For Sale: Complete Bell & Howell home study course, except TV. Includes 10 volumes, oscilloscope, TVM, and design console. All in good working order. Make offer. *Robert C. Knapp, P.O. Box 145, Lyndhurst, Virginia 22952.*

For Sale: Sencore Model TF-151 in/out-of-circuit solid-state tester, perfect condition, \$75. *George Otto, 1045 Magnolia Avenue, Beaumont, Texas 77701.*

Needed: Schematic and/or service manual for reel-to-reel tape recorder Astrocom/Marlux, Model 407. Will buy, or copy and return. *Charles Howes, 26 Mill Valley Road, Pittsford, New York 14534.*

Needed: Power transformer #54-26 for a Heath oscilloscope, Model 0-12. Will buy transformer separate, or an old scope with a good power transformer; other conditions of scope do not matter. *Lloyd Cullen, Lloyd's TV Service, 6152 Hillside Avenue, Indianapolis, Indiana 46220.*

continued on page 12

THE PRO*

LINE IS BIGGER THAN EVER!

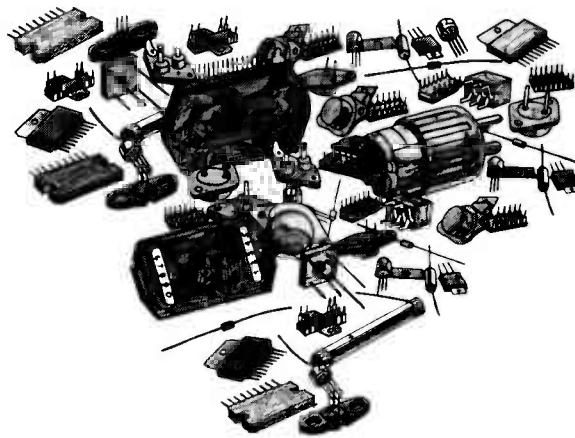

The new expanded line of GE Replacement Semiconductors means one-stop selection in most cases.



The '77 GE Replacement Semiconductor Guide features the new expanded line. We've added over 300 new products to the already tremendous selection to make your life easier.

It's the PRO* Line. For professionals who demand performance and selection. See your Authorized GE Distributor today for your copy.

*Profitable Replacement Opportunities

TUBE PRODUCTS DEPARTMENT
OWENSBORO, KENTUCKY 42301

GENERAL  ELECTRIC

RCA's SK line—Top of the Line in quality—is getting bigger, and bigger, and bigger!

The quality line keeps growing —

RCA's comprehensive line of replacement transistors, rectifiers, thyristors and integrated circuits is now growing at the rate of 20 new SKs every month. That means there will be around 580 RCA types available by the end of the year — bringing the total of domestic or foreign semiconductors that can be replaced by a high quality RCA SK to over 130,000.

Get your 1977 Replacement Guide Supplements —

As the new SKs become available, we'll issue monthly supplements to your Replacement Guide. New applications will cover consumer, TV, Hi-Fi, CB and industrial (power control). RCA Distributors will be able to offer you more selective performance and price choice. Call-backs are all but eliminated because every RCA SK is manufactured to the original OEM quality.

Stay up-to-date. See your RCA Distributor about the new SKs and Supplements. If you don't have the 1977 SK Replacement Guide, ask him for a copy, or write, enclosing \$1.50 (check or money order) to: RCA Distributor and Special Products Division, PO Box 85, Runnemede, NJ 08078.

RCA
SK Replacement
Semiconductors



continued from page 11

Needed: Ameco code-practice oscillator Model CPS-KL or CPS-WL (120-V tube type). Will pay, if good or repairable. *W. W. Blackwell, 521 Gold Street, Toms River, New Jersey 08753.*

Needed: Instruction book and schematic for Knight KG-600B tube tester. Will buy, or copy and return. *Ed Young, 2330 Bedford Drive, Fullerton, California 92631.*

Needed: A B&K Model 470 or 467 CRT tester in like-new condition, reasonable. *Ed Young, 2330 Bedford Drive, Fullerton, California 92631.*

Needed: Schematic and calibration instruction for TS-323/UR frequency meter. *CB Electronics, Box 3 South Main Street, Glassboro, New Jersey 08028.*

For Sale: Complete ham radio station, including transmitters, receivers, meters, tubes, manuals, and parts. Any reasonable offer accepted. *William Paige, W3QMS, 8092 Catherine Avenue, Pasadena, Maryland 21122.*

For Sale or Trade: Devry Tech TRVM multimeter, oscilloscope, and TV training course. Make offer, or trade for a digital multimeter. *Harvey Rousseau, 6 Longview Drive, Milford, Massachusetts 01757.*

For Sale: RCA CR111 picture-tube tester WT333A; RCA WR-508B mini chro-bar generator; Pomona Model 4000 high-voltage test probe (36 KV). All used for one month. \$250 cash for all three. *Dennis Cooper, 802 North Horton Street, La Grange, Texas 78945.*

For Sale: Eico Model 330 RF generator; Eico Model 379 sine/square audio generator; Eico Model 1030 regulated-DC supply; Sencore Model TF/17A transistor tester; EMC Model 801 capacitor checker/bridge; Electronic Designs VTVM; Eico HV probe Model HVP-2; and Eico RF probe Model PRF-11. All items half price, except old VTVM is \$15. *Richard J. Dugo, 29 Mill Street, Dansville, New York 14437.*

For Sale: B&K Model 1801 frequency counter; B&K Model E2000 signal generator; B&K CB Service-master. All slightly used. *Art Sannino, 775 Middletown Avenue, North Haven, Connecticut 06473.*

For Sale: B&K 747 tube tester; \$200, or trade towards B&K 1077B. Used very little. *Howard Johnson, 116 Sherwood Avenue, Belle Vernon, Pennsylvania 15012.*

Needed: Circuit board assemblies Part #702338 and #701338 for Sharp TV Model C-8010. No longer available from factory. *Pat's TV, Star Route, Dupree, South Dakota 57623.*



For Sale: Eico Model 460 wideband oscilloscope with a direct/low-cap probe, \$125; Eico Model 368 TV/FM sweep and marker generator with probes and instruction manual, \$150; Eico Model 147A signal tracer, with probes and instruction manual, \$45; Heath Model 1M-18 VTVM, with probes and instruction manual, \$40; or all four for \$300. *Al Moschella, 8057 Chelwynde Avenue, Philadelphia, Pennsylvania 19153.*

For Sale: RCA Senior Voltohmyst Model WV98A; RCA 3" scope WO33A (hardly used); RCA WG289 HV probe; Pomona Model 2900 HV probe; Simpson Model 262 VOM; EMC Model 212 transistor checker; Cornel Dubilier decade resistance box; Eico Model 232 P-to-P VTVM; Eico Model 1060 battery eliminator (6v & 12v); B&K Model 440 CRT checker-rejuvenator; 2 Endico solder suckers (large and small). *William Aranio, Raynham TV, 803 Orchard Street, Raynham, Massachusetts 02767.*

For Sale: Hundreds of old radio and TV tubes dating back to the 1920s. 90% are brand new; some are used. *Tri-City TV, Route 3, Birch Tree, Missouri 65438.*

Needed: 67-KC multiplex trap coil Number 360091-1 or 360991-1 for Magnavox stereo Model 25T631. Will buy either new or used. *Joseph Ososky, 722 Kimball Avenue, New Kensington, Pennsylvania 15068.*

Needed: 2- or 3-year-old Panasonic Tech 1000 portable AM/FM/shortwave radio in near-mint condition. AC cord must be included with radio. Will pay up to \$50. *Harvey Pearson, P.O. Box 104, Greencastle, Missouri 63544.*

For Sale or Trade: Rider's manuals and following tubes: 00A, 01A, 10, all 7-volt tubes, 6Q7, 2A4G, 7F7, 7F8, all 12-volt tubes, 216B sub, 20, 40, 99, 120, 25B8, FM1000, 70A7, 70L7, 117L7, 117N7, and 81. *Goodwin Radio Shop, Rankin, Illinois 60960.*

For Sale: Sencore SG 165 AM-FM stereo analyzer. Like-new condition, \$400. *Johnnie L. Jones, Rural Route 2, Box 140, Shelbyville, Missouri 63469.*

Needed: Schematic and service manual with parts list for a Soundwave solid-state cassette tape recorder, AC/DC with automatic-level control. *Stephen Z. Opuszynski, 114 Sodom Lane, Derby, Connecticut 06418.*

For Sale: Motorola Training Institute's two-way radio home-study course, excellent condition, \$75. (No substitutes please.) *Gordon K. Bean, Signal CB Service, 2829 Mackinaw Street, Saginaw, Michigan 48602.*

Needed: One or more number 35 tubes for an old radio. *C. Taylor, Box 56, Canaan, New York 12029.*

Goodbye, TV Snow!

By David A. Ferré, Electronic Engineer

Editor's Note: This is the third report about important developments that will revolutionize TV reception. "Goodbye, Color Controls" in the March, 1975 issue of ELECTRONIC SERVICING described the VIR signal of color correction. The VIR signal now is in partial use. Next, "Goodbye, TV Ghosts" in the November, 1975 issue gave the test results of the circular polarization of TV antennas. Approval for CP by the FCC is expected shortly. This month, we're covering the fundamentals of digital video, which can eliminate virtually all of the noise we call "snow". Digital video probably will not be used extensively for several years. Perhaps not until the NTSC system of color TV is replaced by another that can reproduce sharper pictures. But, in the meantime, a knowledge of digital video can help us understand other digital applications.

Are you ready for another "giant step" for color TV? Well, **digital television** is just over the electronic horizon. The NASA pictures from Mars traveled 200-million miles, arriving in excellent condition. That feat would have been impossible

without digital video. Also, routine communications using earth satellites as relays operate now with digital video. There is no argument; digital video can provide pictures with far less noise ("snow") than can any analog system. Of course,

there is one large problem that we'll explain later.

What Is Digital?

Dictionary definitions of digital are not very informative. Most refer to the ancient way of counting by using fingers and toes (digits). Probably "binary" would be more accurate for modern equipment.

New digital equipment

Generally, all of the new digital circuits have signals of square waves, or pulses of various widths (duty cycles), operating at selected repetition rates. All of these waveforms within a given system have the same amplitude.

One important condition of these pulses is expressed by the "state",

continued on page 16

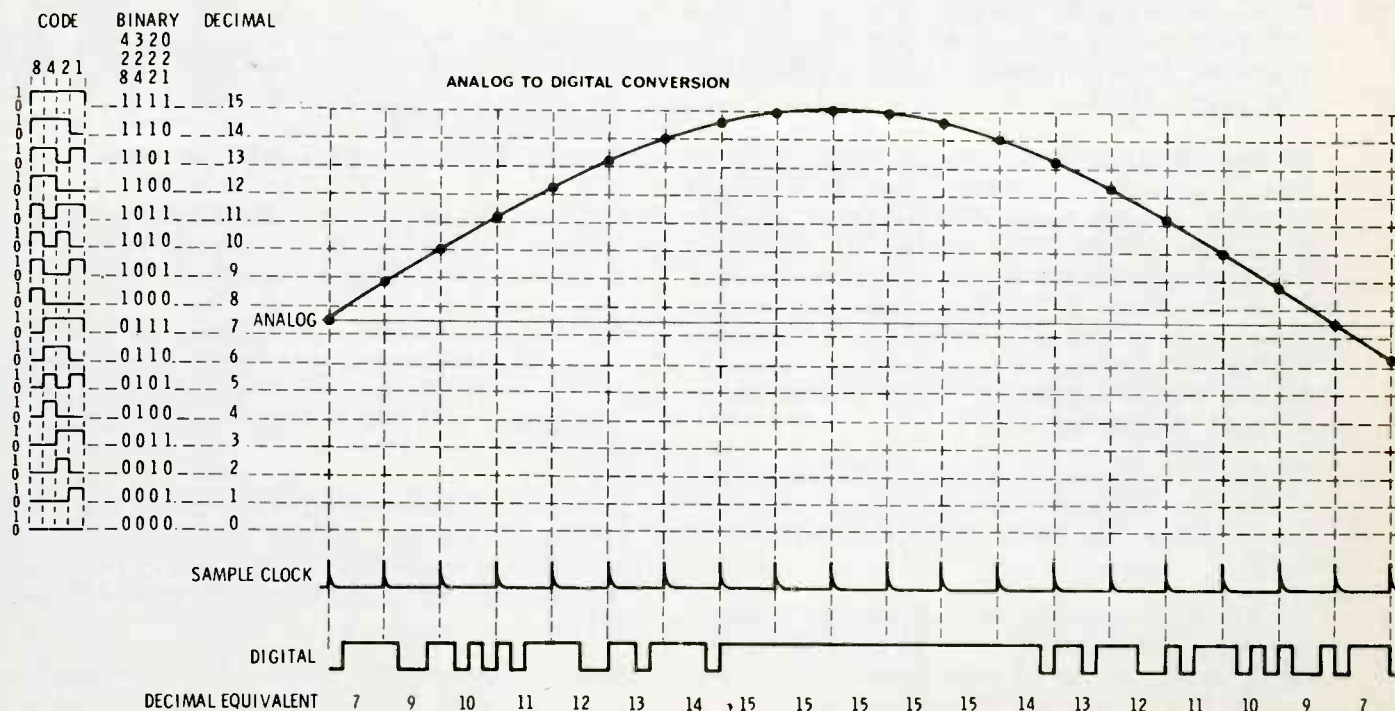



These photographs show a simulated comparison between analog and digital video at a poor 4-dB signal-to-noise ratio.

Fig. 1 This system of analog to binary conversion uses only 4 binary bits, giving digital codes for 16 levels of analog amplitude. Of course, only 16

levels are not enough for good TV, but it illustrates the basic method. The circuit tests the amplitude of the analog signal (the large sine wave)

when it is enabled by the pulses from the clock. Then a digital signal is developed by each of the 16 possible amplitude levels. The three columns at the left show the waveform "code" for each level, the binary equivalent, and the usual decimal number (the right column). Below the clock pulses are the actual binary waveforms for each amplitude level. If you applied this waveform to an integrator (low-pass filter) an approximate sine wave with flattened tips would result. The binary number can be converted to decimal by the 8, 4, 2, and 1 formula. As an example, a binary number 1111 (four highs) is deciphered by adding an 8 for the first high, a 4 for the second, a 2 for the third, and a 1 for the fourth; a total of 15. Or, 0111 translates to zero plus 4 plus 2 plus 1, for a decimal 7.

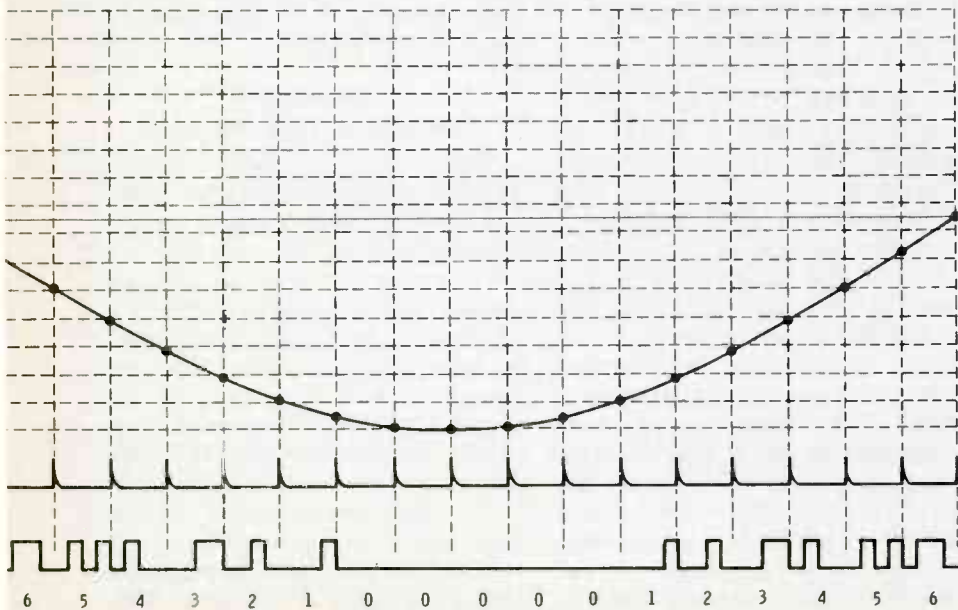

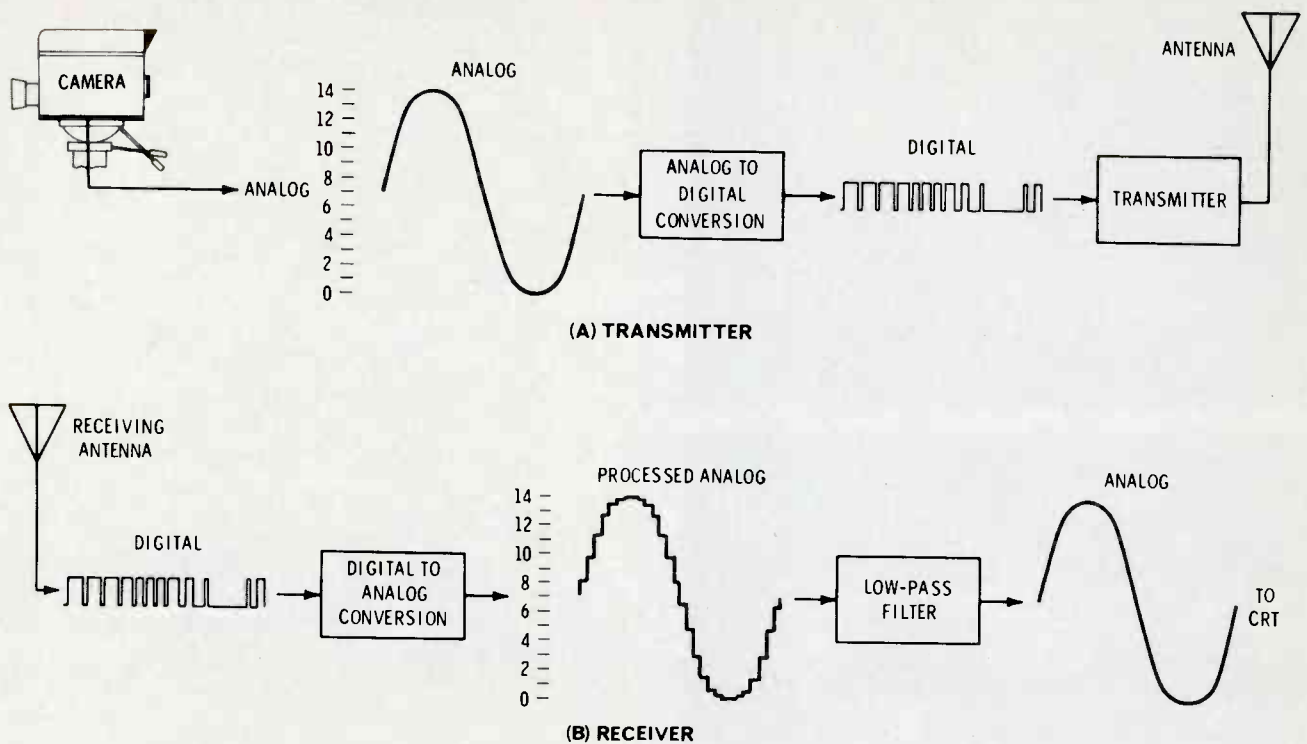

Fig. 2 A digital TV transmitter and a digital TV receiver would require these stages.

TV Snow

continued from page 14

which either is "high" (one, or positive) or "low" (zero, or negative). Therefore, **the signal is very simple and easily interpreted**, although the actual circuitry can be vastly complex.

Also, the readouts or displays of digital test equipment have the conventional decimal figures that do not require any interpretation. For example, the DC-voltage reading of a digital multimeter consists of a polarity followed by the numbers of the voltage, including the proper decimal point. By contrast, with an analog DC voltmeter, you must check the polarity, find the proper scale, and finally locate the exact point on the scale. Digital readings, thus, are easier and faster to obtain, in addition to having higher accuracy.

Video

In the composite-video waveform, the blanking and sync pulses might be considered as digital; they are

pulses that do not change in amplitude. However, the video signals between these pulses usually are analog types that gradually vary in waveshape and amplitude.

Perhaps we should define digital by saying: If it's not **totally** digital, then it's analog.

Conversion From Analog To Digital

Figure 1 shows how an analog sine wave can be changed into a coded digital signal. A "clock" (an oscillator that supplies the desired frequency) sends pulses to the sampling circuit. Each pulse activates the circuit, which briefly examines the amplitude of the signal at that precise time, and emits a digital code number.

This system has four binary "bits", and each bit represents a power of 2. Therefore, the four binary numbers have the values of 8, 4, 2, and 1, as shown above the "code" column. Four bits give a total of 16 different combinations representing 16 amplitude levels. These bits can be changed into the

usual decimal numbers, as listed in the "decimal" column. Notice also that two "highs" occurring in succession do not appear as two pulses, but they combine to form a pulse having double the single width.

Reverse the process, and the digital code will form a rough approximation of the sine wave, as illustrated in Figure 2.

Why Use Complex Digital Stages?

Digital television would require an analog-to-digital converter at the transmitting station, and a matching digital-to-analog converter in **each** receiver to recover the original analog video signal. What advantage of the digital system could be important enough to offset the extra cost and complexity of the digital stages? It's that virtually all of the noise (snow) can be eliminated from the digital video signal.

A noisy analog signal cannot have any actual or apparent snow removed without an unacceptable loss of picture sharpness. Yes,

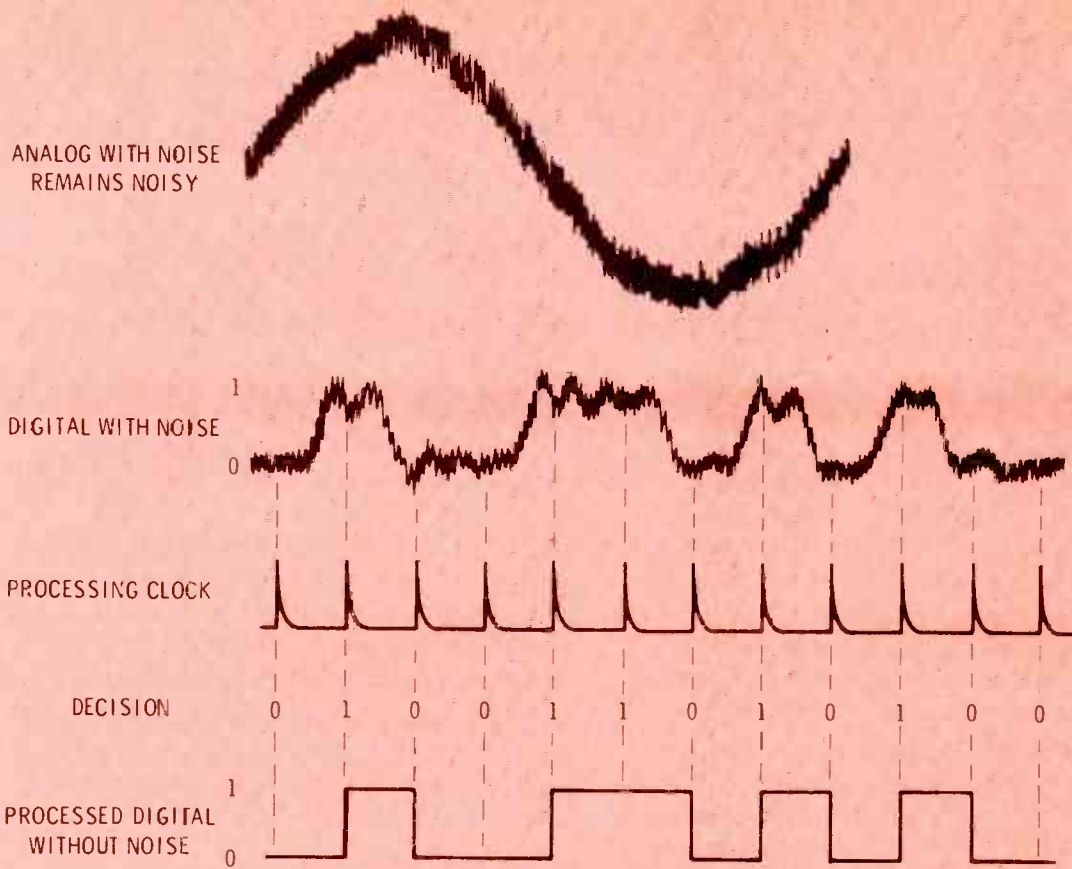

Fig. 3 There is no effective way of removing noise (snow, when seen on the picture tube) from an analog signal. A distorted digital signal with strong noise can be sampled by a clock circuit to determine

whether the signal is high or low at the time of each pulse. From the high/low data, a new noise-free digital signal is created.

limiters or clippers might remove noise spikes that are much stronger than the signal, but they can't remove any snow.

Noisy digital signals, on the other hand, can be converted into noise-free, sharp-edged digital pulses, provided that enough of the original waveform can be found in the noise

to indicate whether each area is a high or a low (see Figure 3).

The amplitude of the digital signal with noise is sampled at the time of each clock pulse. The processing circuitry decides whether the amplitude indicates a high or a low, and this data is used to generate new pulses. Because the

new pulses are not made directly from the old ones, but are created from the high/low decision, they are as sharp and noise-free as any pulses from a generator.

Other advantages

Although a change to digital *continued on page 20*

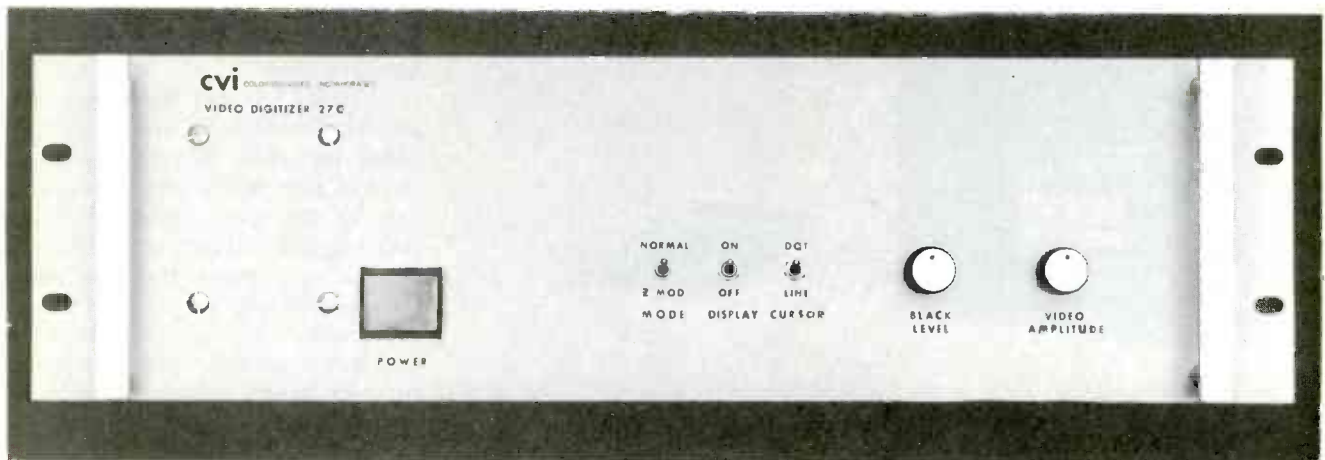

Colorado Video offers Model 270 Video Digitizer, which converts standard television video signals into digital data for computer processing. The device uses an 8-bit binary

word, that provides for 256 levels of analog amplitude. (Courtesy of Colorado Video, Inc.)

RCA helps you do it all—faster and more profitably.

RCA knows what you need for fast efficient service.

Your RCA Distributor can quickly solve your stocking and ordering problems because he represents RCA's Distributor and Special Products Division — one of the industry's largest single sources for your electronic servicing needs.

You name it — we'll supply it. Receiving tubes; color and black-and-white picture tubes; SK replacement semiconductors; exact replacement parts; antenna hardware; outdoor and indoor antennas; antenna rotators; industrial tubes; test jigs; reception and servicing aids . . . and the list goes on.

And that's not all. The size and scope of RCA's activities in electronics means you can get the latest, most advanced products. Backed with extensive promotional support; advertising programs; handy directories, catalogs and cross-reference library.

Get the full story from your RCA Distributor. Or write RCA Distributor and Special Products Division, 2000 Clements Bridge Road, Deptford, N.J. 08096. Attn: Sales Promotion Services.

RCA Distributor and Special Products Division

TV Snow

continued from page 19

video could nearly eliminate snow at the present time, there are other advantages in the future.

Flat-screen large-area television panels are very desirable. And such

panels might be on the way with further development of liquid crystals, LEDs, charge-coupled devices, and logic microprocessors (small specialized computers). Burroughs, Hughes, Northrup, RCA, Texas Instrument, Westinghouse, and others are developing flat displays.

Digital techniques are more compatible with flat screens, because each picture element can have a digital address, and the incoming digital waveform could be sent directly to the display device.

Scanning of height and width also would be done digitally, without the yoke, and the large amounts of power it requires. Therefore, a TV chassis would resemble a microprocessor, with rows of ICs, and little else.

A typical digital flat-screen TV probably would be made in two units; one unit for the electronic circuits and tuner, and a separate one for the panel screen. Perhaps radio signals will be used to replace the wiring between the two units, thus simplifying servicing. In case of trouble, only the one defective unit would require transportation to the test bench, where it could be operated with a digital test jig.



Analog-to-digital converters are not necessarily large. This one by Computer Labs occupies only 21 cubic inches, but it can handle color-TV video with frequencies up to 11 MHz. The price is around \$1,000, but a D/A converter for receivers might cost about \$150. (Courtesy of Computer Labs)

What's The Catch?

Most improvements have drawbacks, and digital video is no

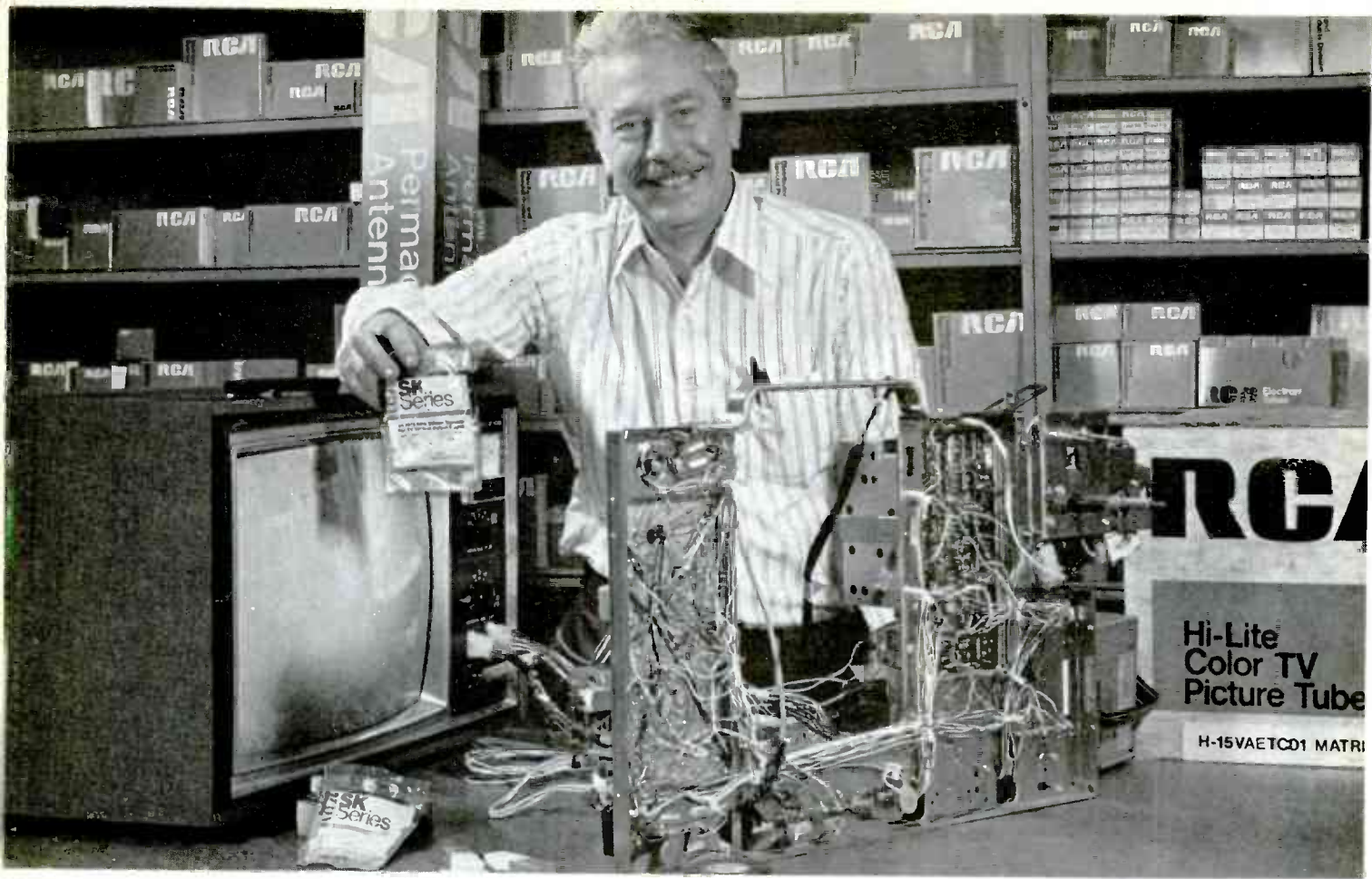

exception. The only large problem is: **BANDWIDTH**. One digital TV channel would require about a 100-MHz bandwidth, which is about 16 times wider than the present channel allocations.

Obviously, this cannot be done within the VHF band. Even so, there is a solution. If the television signal originated from a space satellite with a carrier of 12,000 MHz (12 gigaHertz), then a TV channel occupying from 12 GHz to 12.1 GHz seems reasonable.

In fact, even less bandwidth would be required, since all of the video, chroma, and sound information is contained in a **single digital signal**. Bandwidth-compression schemes might reduce the bandwidth even more.

Satellite Business Systems (owned in part by IBM) has scheduled the launch of an all-digital, high-power, 12-GHz satellite for 1978. If this satellite is successful, the revolutionary change to digital communications will begin, and tele-

continued on page 22

Flat television screens, such as this one simulated by Eastman Kodak, probably will be compatible with digital television. A 2.5-by-5 foot display with 1,100 TV lines would provide excellent sharpness, and the digital video will eliminate the snow. (Courtesy of Eastman Kodak)

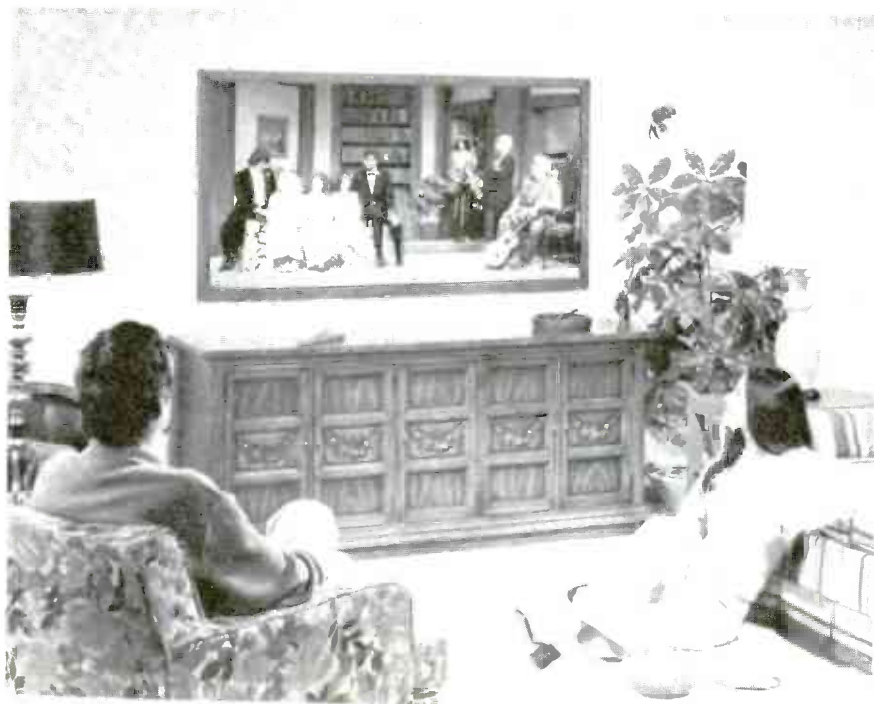

**NEW
AUTOMATIC
IN-CIRCUIT
SEMICONDUCTOR
TESTING
AND LEAD
IDENTIFICATION**



for
all bipolar transistors
(including hard-to-
check Darlington),
FET's, SCR's,
diodes.

**Model 520B
Semiconductor Tester
\$160.00**

New HI/LO power drive circuitry permits accurate testing of even more transistors and other semiconductors in circuits with shunt resistance as low as 10 ohms and shunt capacitance up to 15 μ F. New low power drive automatically identifies base, emitter and collector leads, in or out of circuit.

Test takes 9 seconds or less. Audio tone and LED's indicate GOOD/BAD, NPN-OK or PNP-OK.

Ideal for production line, inspection, and field service applications.

Contact your local distributor for a demonstration or write for detailed brochure.

B+K PRECISION
PRODUCTS OF DYNASCAN

6460 West Cortland Avenue
Chicago, Illinois 60635 • 312/889-9087
In Canada: Atlas Electronics, Toronto

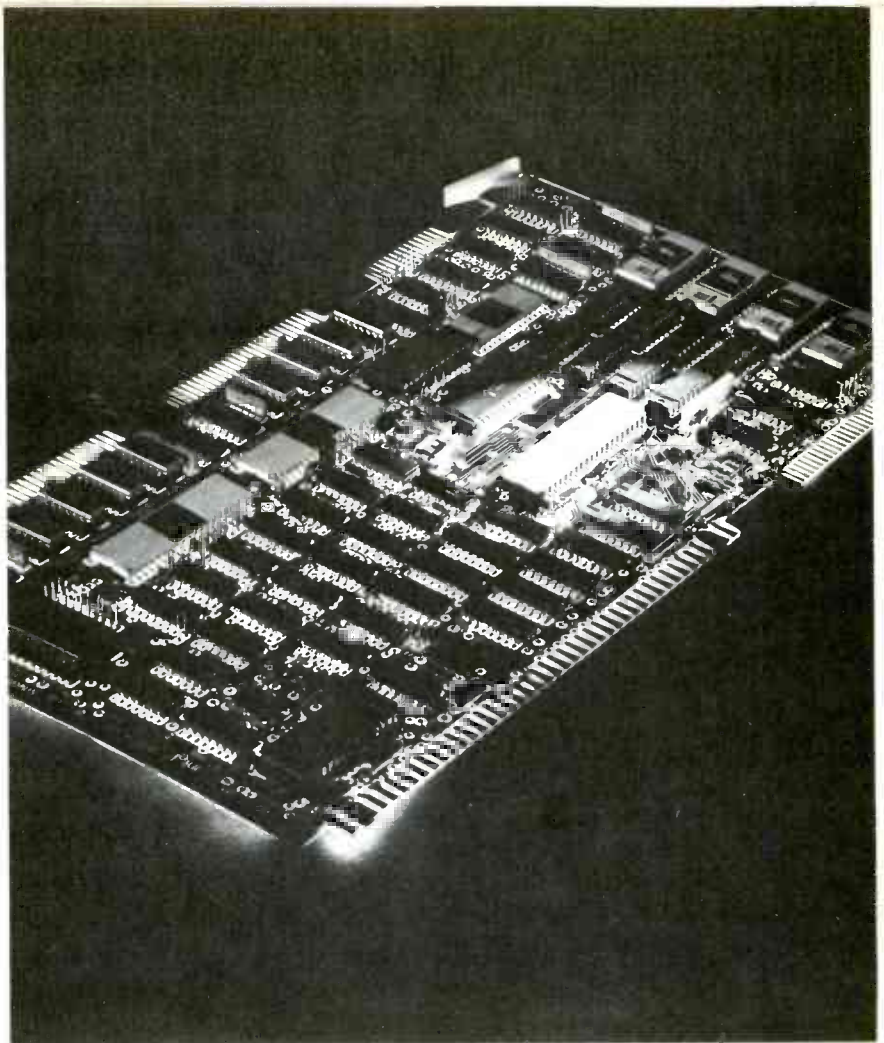

In the future, a digital television chassis might have an appearance similar to this microprocessor; with many ICs, but no bulky sweep stages. (Courtesy of Intel Corporation and EDN)

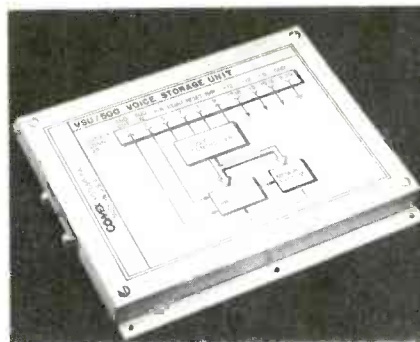

Another advantage of digital video is that the waveforms can be stored by a computer-like system. Believe it or not, this is the digital equivalent of an audio tape recorder/playback! There are no moving parts in the VSU-500 Voice Storage Unit by Comex, but a 12.5-second message can be recorded and stored for unlimited playbacks. The unit is handheld size. (Courtesy of Comex Systems)

TV Snow

continued from page 21

vision will be an important part of it. Eventually all national TV programs will be relayed to the local TV stations via satellite.

There are two main possibilities for improvement of the quality of TV pictures. One is a change to about 1,100 lines (from the present 525). Of course, this would make all present transmitting and receiving equipment obsolete.

Or, a new standard might be adopted for digital video, and older receivers could use an adapter or converter to allow viewing of the new stations.

Presently, the color-TV market is almost saturated, and operating in a replacement cycle. Both the TV manufacturers and millions of consumers would welcome a radically new product. Digital-video TV receivers might be the answer!

For More Details Circle (8) on Reply Card

WINEGARD WORKS... For Us!

In its little more than two years existence, the Davis Antenna Company of Waldorf, Maryland has shown phenomenal growth. Brothers Buddy and Raymond Davis expect to put up more than 2,500 Winegard antenna installations in 1977, over half of them with Winegard's new low noise pre-amps. Having tested many different manufacturer's products in the tough reception areas surrounding Washington, D. C. the Davis brothers now use Winegard products exclusively.

"It seems we get a lot of the reception problems other people can't solve," Buddy said, "and we know from experience that if it is at all possible to get a decent picture, Winegard equipment will do it. We use a wide variety of Winegard models in both the Chromstar and Gold Star antenna and preamplifier lines."

The Davis Antenna Company also has branched out into MATV installations and here again, use Winegard electronic products exclusively. "We have attended several Winegard MATV seminars and they have really helped us in a professional way," president Buddy Davis said. "We give a one-year guarantee of satisfaction to both our MATV and antenna customers because Winegard products have proven very reliable. In addition, we don't cut corners on our installations."

You, too, can enjoy greater success in the television reception business by going first-class with Winegard.

Winegard works...for professional installers all over the country. Let us work for you. Just call your Winegard distributor or write to us.

Buddy Davis (l.), Raymond Davis (r.), Davis Antenna Co. Waldorf, Md.



WINEGARD

The Winegard Company • 3000 Kirkwood Street • Burlington, Iowa 52601



Servicing GE Modular Color TV, Part 9

Analyzing VIR Tint and Color Controllers

By Gill Grieshaber, CET

Concluding our coverage of the General Electric VIR module, we discuss the circuits of the tint controller, the color-level controller, and the manual/VIR-control switching.

The first functions of the General Electric VIR module (Figure 1) are: counting to Line 19 of each video field; generating a 63-microsecond pulse that corresponds to the time of Line 19; and from that pulse, creating a 15-microsecond pulse and a 35-microsecond pulse. These latter pulses occur during the time of the 63-microsecond Line-19 pulse.

Next, the 15-microsecond pulse and the composite video are applied to the VIR-sensor circuit. When the video contains VIR waveforms on

Line 19, DC switching voltages are produced. But, without the VIR waveform, the switching voltages are reversed.

We have stated these circuit operations very simply, because it is essential that we understand the general purposes of all functions, and not become confused by the details.

Only two major circuits remain to be explored. They are the tint-controller and color-controller circuits. Included with them are the stages that switch the TV receiver to automatic VIR control when the VIR signal is broadcast.

Basic VIR Facts

Any degradation of the regular color-program signal (because of shortcomings in the television broadcast system) will occur to the VIR waveform, also. Therefore, when adjustments are made to restore the VIR signal to the original waveshape, the color and tint errors of the broadcast will be corrected at the same time. That's the purpose of the VIR signal.

This is the theory for the VIR correction of tint errors: **When the amplitude of the chrominance reference and the amplitude of the black level of the VIR waveform are equal in the R-Y signal of the receiver, the receiver tint matches the tint of the color program at the point of origin.**

The chrominance reference occurs during the time of the 15-microsecond pulse, and the black-level reference occurs later during the time of the 35-microsecond pulse. Therefore, these pulses are

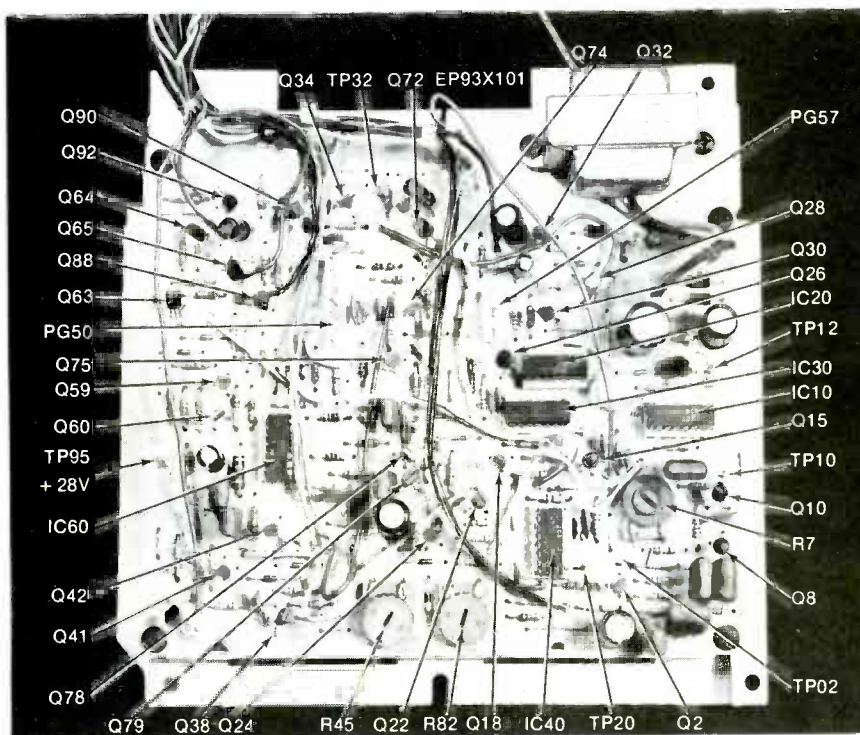

Fig. 1 Arrows show the locations of many transistors, ICs, and other major components on the General Electric VIR module.

used to activate the two gates of a comparator, and **the amplitudes at those times can be compared.** In other words, the comparators are "dead" until the pulses arrive. It's not important that the pulses do not occur at the same time, for the comparator holds the reading between the pulses.

These GE receivers change tint (both automatic and manual) by adjustments of a DC voltage that's applied to an IC in the chroma channel. Almost all of the new solid-state color sets operate this way.

When the VIR circuit is in control, the output of the tint comparator goes to the tint IC in the receiver (see Figure 2). The output is about +7 DC volts, and it varies slightly, as needed to maintain the correct phase of the color.

The transistor switches operate from the VIR-sensor switching DC voltages to transfer the tint control from manual to automatic, when the video has a VIR waveform on Line 19.

We are ready now to analyze in detail the tint-comparator circuitry.

Tint Controller

R-Y demodulated chroma enters the VIR module at R37 (see the schematic in Figure 3), and is applied to the base of Q38. Some high-frequency attenuation is provided by R37 and C37. Q38 is wired as an emitter follower, having a gain of slightly less than 1. The waveforms at base and emitter are shown in Figure 4. Of course, these waveforms vary constantly according to the chroma portion of the picture.

From the emitter of Q38 (TP38), the R-Y signal goes through R40 and R39 to the bases of Q42 and Q41, which are operated as keyed switches.

At the base of Q42, diodes Y40 and Y42 prevent the R-Y waveform from reaching the base, except during the time the 35-microsecond pulse is there. The 35-microsecond pulse has zero voltage all of the time, except for this portion of Line 19; and when it is "low", the positive voltage from the emitter of Q38 travels through R40 to forward bias Y40, which shorts the R-Y signal to ground. In addition, the anode of diode Y42 has insufficient positive voltage to permit con-

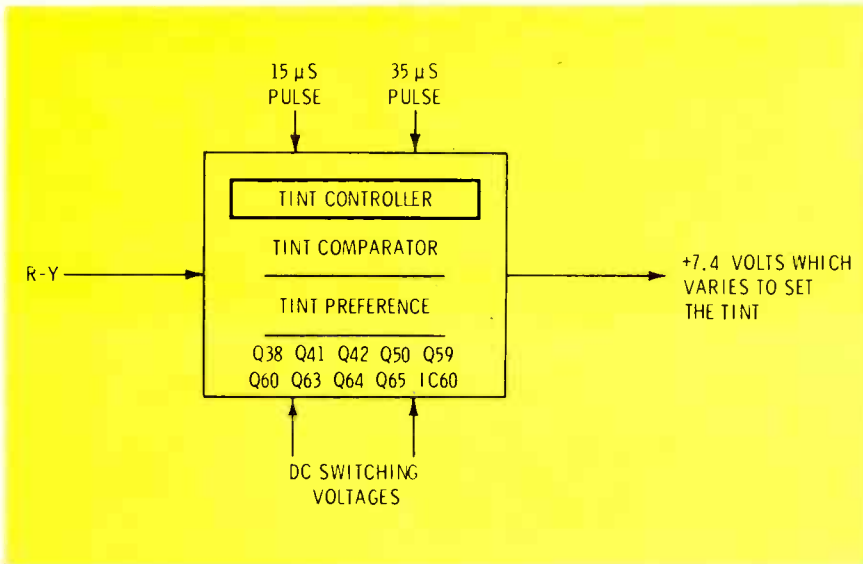

Fig. 2 Input to the tint controller section is a sample of the R-Y chroma signal. The pulses activate the gates of the tint comparator, and the DC switching voltages change the operation from manual to automatic VIR control. The output DC voltage goes to the tint IC in the TV chassis, where it varies enough to maintain the original tint.

duction. Both actions eliminate any chance of the signal reaching the base of Q42.

When the positive-going 35-microsecond pulse reaches the cathode of Y40, it is reverse bias for Y40, which becomes an open circuit. With the former short removed, the junction of Y40 and Y42 becomes positive. This forward biases Y42, passing the R-Y signal and DC to the base of Q42.

Reversed bias?

Let's pause for a moment to consider the bias of Q42. According to the DC meter readings shown on the schematic, Q42 is highly reverse-biased. But, the emitter voltage shows conduction does take place.

The answer illustrates some truths about pulse circuits. C42, at the emitter, smooths and stores the DC voltage, so the peak voltage and the DC voltage (as read on a meter) are nearly the same. Not so for the base voltage. When the pulse unlocks the gating diodes, the base receives more than 5 volts, and the C/E current is high. However, the pulse allows base voltage for only about 0.92% of the time. Therefore, the **average** DC is only slightly greater than +0.7 volt.

Where is the signal?

Trying to obtain meaningful waveforms in this stage is frus-

trating. You see, R40, Y42, and the base resistance of Q42 reduce the R-Y signal amplitude. Also, the tiny amplitude that remains is mounted on top of a 13-VPP pulse, so it's nearly invisible. Figure 5 gets around the barrier, by showing the pulse as one trace, and the R-Y signal from TP38 for the other trace.

Figure 6 shows the waveforms at TP40; the base of Q42; and the emitter of Q42. The emitter voltage remains at a high level for far longer than the time of a horizontal line. In fact, the waveforms of Figure 7 prove that the voltage does not reach zero during each field of 262.5 lines (59.94 fields per second).

Also, there are some discrepancies between the waveforms of Figure 7 and the waveform drawings in the GE literature about the VIR circuit. GE shows the waveform at pin 10 of IC60 as a flat-topped sawtooth, but the waveform actually found there has a large negative-going pulse and a slight valley in the nearly-straight line at the top. I can say only that the last waveform of Figure 7 was found in a new GE receiver, which was working perfectly.

However, the waveform at the output of IC60 at pin 10 changes greatly when the VIR is missing, or the VIR switch is turned off (see Figure 8). The waveform with the

continued on page 26

Fig. 3 This is the complete schematic of the tint controller in the YC-2 chassis by General Electric.

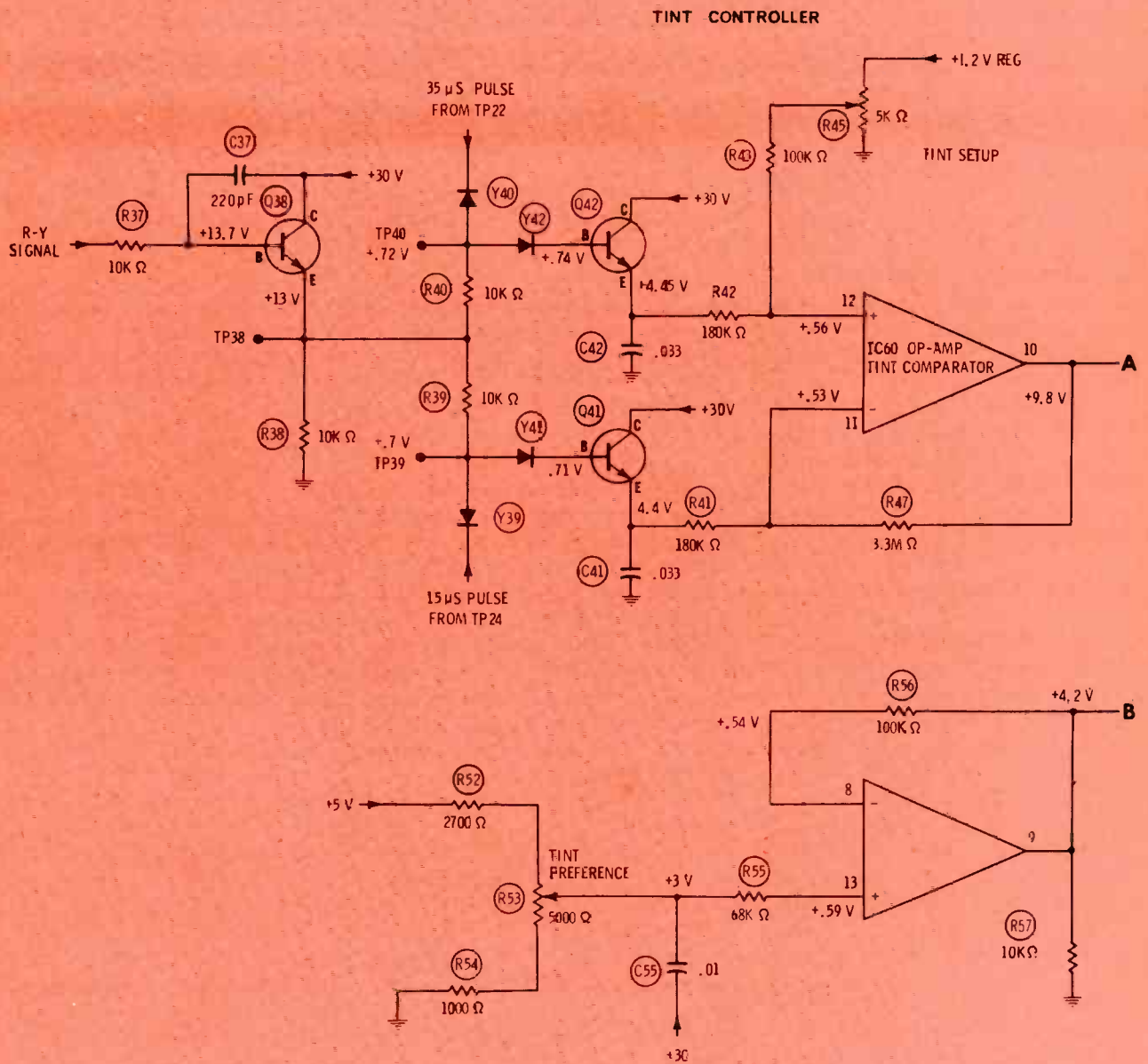

Analyzing VIR Tint

continued from page 25

VIR switch turned **off** resembles the GE drawing, except it is upside-down. Perhaps the GE draftsman used the waveform for no-VIR operation, and accidentally inverted it.

The waveforms around Y39, Y41, and Q41 are similar to those in the Q42 stage just described, except for

the narrower width of the 15-microsecond pulse.

Tint comparator

The DC voltages stored in C41 and C42 are applied to the two inputs of IC60, which is an op-amp wired to act as a difference amplifier. The "tint-setup" control is provided to balance the two inputs, by varying the DC voltage at pin 12. A wrong adjustment of R45

affects the discharge curve of C42, unbalances the comparator, and distorts the waveform at the output, pin 12. Until a foolproof method of adjusting R45 is presented, we suggest that you do not change the setting.

The output signal at pin 12 of IC60 is filtered to remove the AC, leaving a DC voltage that varies with any degradation of the VIR waveform.

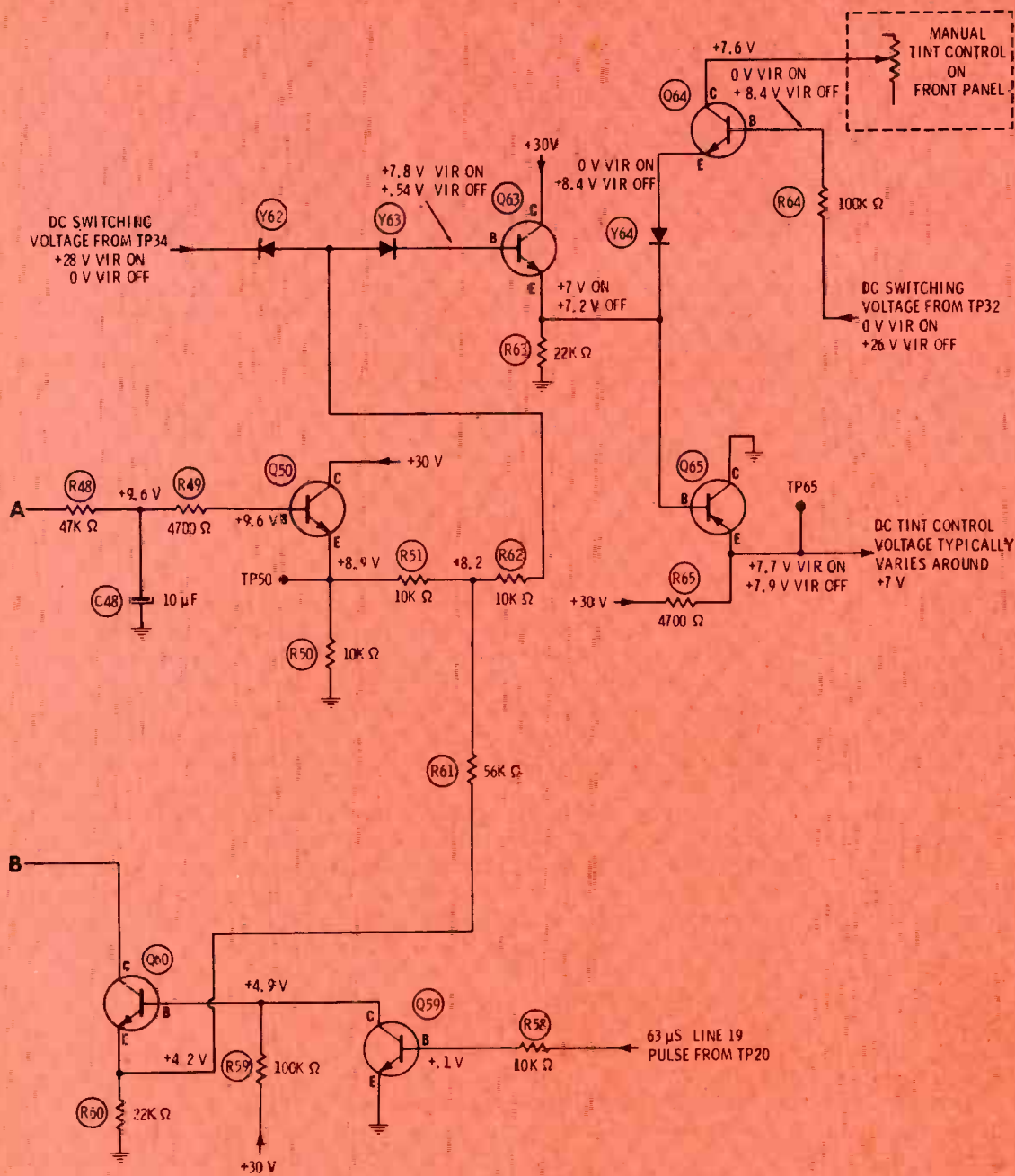

Automatic/manual switching

After the filtered DC voltage is applied to the base of Q50 (an emitter follower), the output from the emitter goes to the common point between Y62 and Y63, the switching diodes.

When the VIR waveform is present, a high positive DC voltage is applied to the cathode of Y62, stopping all conduction. However, the positive emitter voltage from

Q50 forward-biases Y63, causing conduction and sending the voltage as forward bias on to the base of Q63. The emitter voltage of Q63 is fed to the base of Q65, another emitter follower. The Q65 emitter voltage is routed to the tint IC in the TV chassis, where it controls the tint, automatically.

Manual tint

The previous explanation ignored

Q64. With VIR, R64 has no DC voltage, so Q64 cannot conduct. When that happens, diode Y64 is reverse biased, disconnecting the emitter of Q64 from the emitter of Q63.

However, when the VIR control is turned off, or the station does not broadcast the VIR waveform, the base of Q64 has a high DC voltage. It's so high that Q64 is

continued on page 28

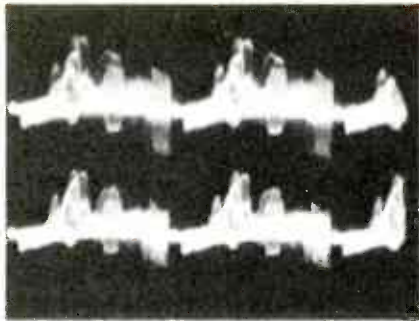

Fig. 4 Amplitude and waveshape of the R-Y input signal change constantly, according to the TV picture. The top trace shows a typical waveform; and the lower dual-trace is the same signal at TP-38, after it has gone through a high-pass filter and an emitter follower.

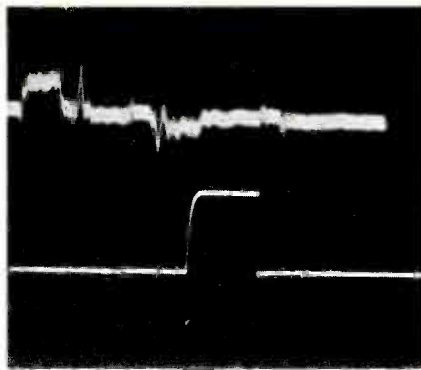

Fig. 5 Shown by the top trace is the R-Y signal of Lines 18, 19, and 20 (approximately); and the 35-microsecond pulse that keys-on the tint comparator during the time of the black-level reference is shown by the trace at the bottom. I could not find any point of the circuit that showed both of these signals together.

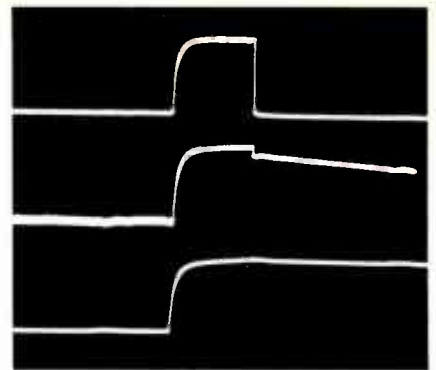

Fig. 6 These are the waveforms at Q42. Top trace shows the 35-microsecond keying pulse at the anode of diode Y42; the base waveform of Q42 is pictured by the center trace (notice that the voltage drops slowly after Y42 stops conducting); and the bottom trace is the waveform at the emitter of Q42. The scope sweep was about 0.15 microsecond plus X5 expansion.

Analyzing VIR Tint

continued from page 27

saturated. During that time any variation of the collector voltage is passed through the transistor to the emitter (as though the transistor were shorted). And the collector voltage is supplied by the manual tint control, which is located on the TV front panel.

The emitter voltage of Q64 now is more positive than the emitter voltage of Q63, so diode Y64 conducts the Q64 emitter voltage on to the base of Q65, giving manual control of the tint.

At the same time, the cathode voltage at Y62 is zero, and the anode is positive. Therefore Y62 conducts, grounding the base supply of Q63; Q63 is cut off, preventing any automatic tint action.

Tint preference

If a viewer should prefer a different tint setting from the one used for the original program, a control is provided to furnish a small shift of tint during VIR-controlled operation.

However, the VIR tint correction is part of a closed loop, and the automatic operation would try to cancel any manual adjustment. So, a special circuit is included to disconnect the "tint preference" voltage during Line 19, when the tint controller is working. Here's how it operates.

The tint-preference control (mounted on the receiver back, near the top of the cabinet) varies a small DC voltage at the input of another op-amp inside IC60. IC60 amplifies the voltage, and the DC output from pin 9 is applied to the collector of Q60.

At this time, Q60 is completely saturated, because of a high base voltage coming through R59. Therefore, the emitter and collector voltages change together, both varying in step with the output of IC60. This emitter voltage, which varies with the tint-preference adjustment, goes through R61 to join the automatic tint-correction voltage at the junction of R51 and R62. So, the tint-preference slightly changes the automatic tint.

However, the 63-microsecond Line-19 pulse supplies a positive base voltage for Q59 (which previously was cut off), and the C/E path of Q59 conducts, thus shorting the base bias of Q60 to ground. Without forward bias at the base, Q60 cannot conduct, and the emitter voltage drops to zero. Therefore, during the time of the 63-microsecond pulse, the tint-preference control setting does not affect the action of the automatic-tint circuit.

Automatic Color Controller

Operation of the VIR color controller (see the block diagram in

Figure 9) is similar in many ways to that of the tint controller. Therefore, we will not repeat the entire explanation, but instead discuss only the differences.

The basis for the color correction is this: **When the amplitude of the chroma reference equals the amplitude of the black-level reference in the blue-drive signal, the color saturation is the same as it was in the color program at the originating studio.** Therefore, the color corrector operates in a closed loop to keep those amplitudes matched.

Blue drive

The blue-drive waveform is simulated by combining the demodulated B-Y signal and a sample of the Y (video) signal. One advantage of the two signal sources is that the amplitude of the Y signal can be varied to slightly change the color level during automatic operation. Notice the "chroma-preference" control in the lower-left corner of the schematic in Figure 10. From the preference control, the Y signal goes through two emitter followers before it joins the B-Y signal at the emitter of Q74.

Color comparator

From Q74 to the output of another op-amp in IC60, which is used as the color comparator, the circuit is nearly identical to the one in the tint corrector. Notice the "chroma setup" control that varies

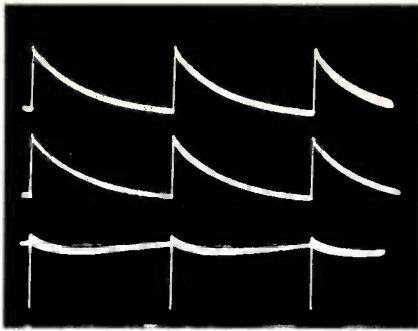

Fig. 7 These are the input and output waveforms of the tint comparator. At the top is the waveform from the emitter of Q42; in the center is the similar waveform from the emitter of Q41; and the bottom trace is the output of the tint comparator (the amplified difference between the first two). A scope sweep of about 3 milliseconds was used to show about 2½ complete fields.

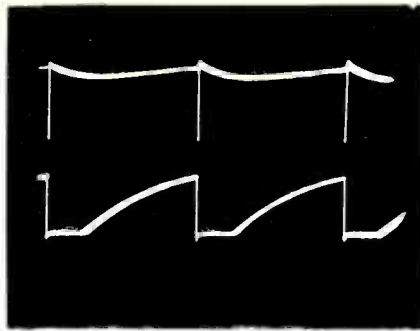

Fig. 8 The output waveform of the tint comparator is greatly different without the VIR. Top trace is the output waveform from the tint comparator in IC60, when VIR control was used. After the VIR was switched off, the waveform resembled a flat-bottomed sawtooth (lower trace).

(also at TP92) control the chroma gain so it becomes the same as it was at the studio which originated the color program.

If the VIR waveform is not broadcast, the DC switching voltage from the sensor circuit now is zero at the cathode of Y87. Since the anode has about +5 volts, Y87 is forward biased. It conducts, grounding the DC voltage that supplies the base of Q88. Diode Y88 is cutoff, and no positive voltage reaches Q88's base. Therefore, Q88 can't supply the automatic color-level voltage to the base of Q92. That part of the circuit ceases to affect the color.

However, the bias situation at Q90 is just the reverse. VIR operation removes the forward bias from Q90; but with no VIR waveform, the switching voltages supply a high forward bias to saturate the transistor. While Q90 is saturated, the emitter voltage equals (and follows) the collector voltage; and the collector voltage is supplied by the manual color control, which is located on the TV front panel. Now the manual color-control voltage reaches the base of Q92 (via Q90), and adjustments of the control change the color-saturation level.

Did you notice that it was not necessary to disable the color comparator during the Line 19 time? That's because the "chroma preference" operates by adjusting the amount of video to be mixed with the B-Y signal, and not by changing the DC voltage from the comparator.

Power Supply

A small power transformer, 4 diodes in a bridge, two filter capacitors, and a zener comprise the regulated +5-volt supply. All of the other DC voltages are borrowed from the TV chassis, via the cables.

Troubleshooting The VIR Module

Symptoms of component failures on the VIR module divide naturally into two basic types.

Some defects merely eliminate the VIR automatic action. Before you become an expert in troubleshooting these modules, it's likely you would just replace the module.

Other symptoms of troubles are more complicated, because some

continued on page 30

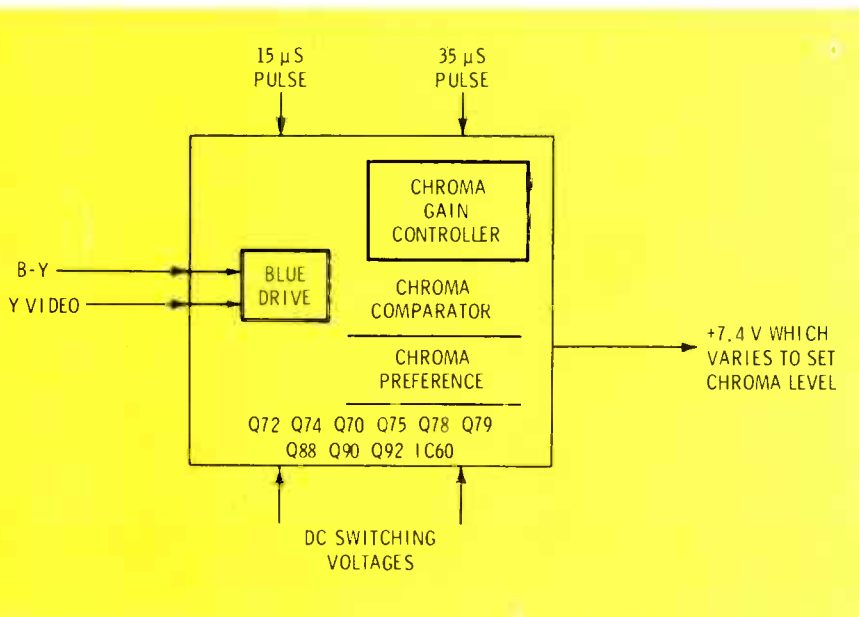

Fig. 9 Except for the input source, the chroma gain controller block diagram resembles that of the tint controller. Blue drive is made by adding video to the B-Y chroma signal. To provide some variation from the correct color level, the color-preference control changes the amplitude of the video that's combined with the B-Y.

the voltage of pin 2 if IC60.

Beyond the color comparator, however, the circuit is different.

Chroma amplifier

Another op-amp in IC60 functions as a non-inverting DC amplifier, to increase the small DC output from the color comparator. The amplified DC voltage goes to diodes Y87 and Y88.

DC switching

The first automatic/manual

switching is a function of Y87 and Y88. With the VIR signal, the cathode of Y87 is more positive than the anode, so Y87 is cutoff. But the anode of Y88 is positive, thus permitting the positive voltage to reach the base of Q88. Output of Q88 is from the emitter, and this DC voltage goes through R89 and R91 to the base of Q92, another emitter follower, which in turn feeds the emitter DC voltage to the chroma IC in the TV chassis. Variations of the emitter voltage

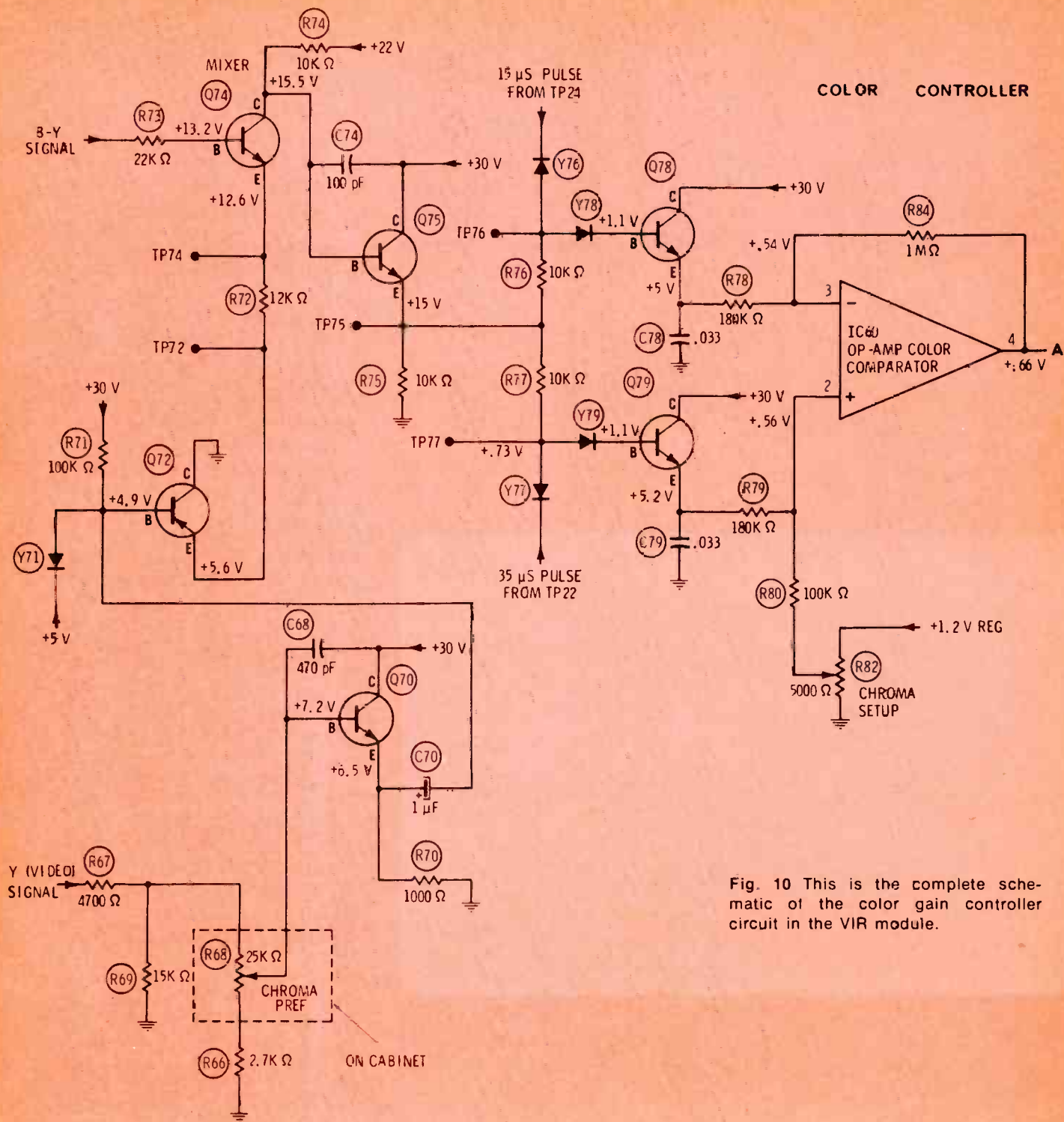

Fig. 10 This is the complete schematic of the color gain controller circuit in the VIR module.

Analyzing VIR Tint

continued from page 29

parts failures can affect the performance of circuits in the TV chassis, even circuits not related to the VIR operation.

Follow this sequence of tests:

- Determine whether or not the VIR signal is being broadcast. Check all of the local channels, noticing the response of the tint and color, and if the VIR LED

lights. (Incidentally, I thought NBC was not using the VIR waveform, for the VIR light **never** came on. But the scope waveforms showed the VIR waveform was on Line 20, instead of Line 19. The first use of VIR was on Line 20, and evidently NBC has not changed over yet.) Use your triggered scope, as we suggested last month, to prove without any doubt if the VIR is being broadcast.

- Try the action of the "color

preference" and "tint preference" controls. Normally, the change is less than half of that possible with the manual controls, but some change of color and tint should be possible.

- Visually inspect the module, as you would any circuit board, for bad solder joints, burned resistors, loose plugs, or solder bridges.

- If all else fails, and you don't have a new module to try, turn off the power to the receiver, unplug

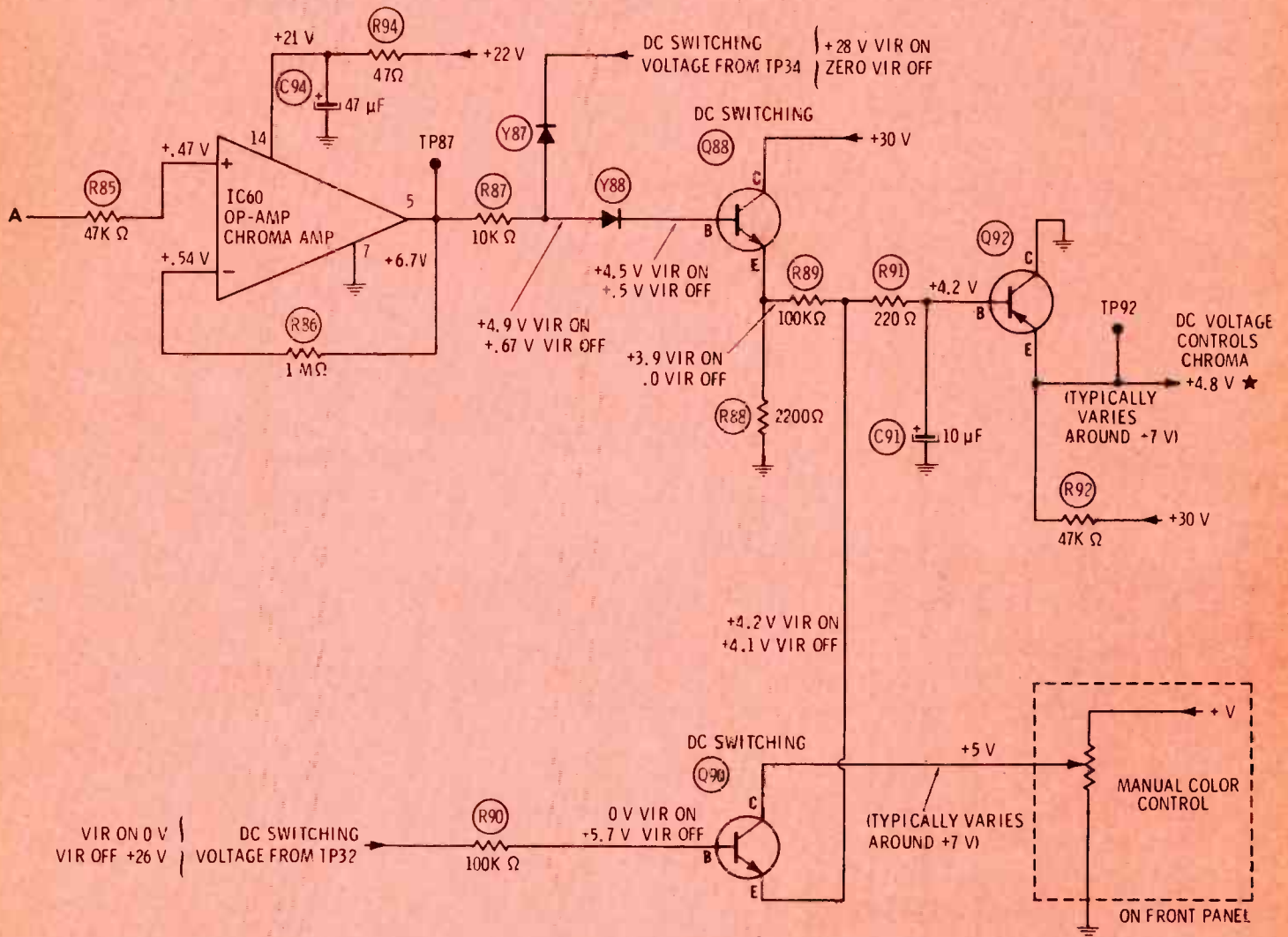

the two 3-pin connectors, and then connect together the 3-pin PG53 (that comes from the front panel tint and color controls) to the 3-pin RL54 receptacle (that's wired to the chroma circuits of the color-TV receiver). This connection bypasses the entire VIR module, so if the manual color controls, and all other functions (except the VIR automatic control), operate normally now, it's positive that the VIR module is defective. At this time,

we do not recommend that you attempt to adjust any of the controls on the module.

Comments

These last three articles (about the General Electric VIR "Broadcast-Controlled" color and tint automatic circuits) conclude our coverage of the GE modular color-TV receivers. Obtaining some of the waveforms required operating the scope near the outer limits.

However, we wanted you to see the actual waveforms, and use them as standards for your own tests in the future.

Although the digital circuitry is rather extensive, none of it is exceptionally complicated. Certainly, a competent TV technician should be able to diagnose and make repairs, with little more than the usual technical problems. Most of all, **don't be afraid of the VIR module.** □

Wire you waiting?

By Edmund A. Braun

Take a "puzzle break" and have fun solving this Just-Across-Word Puzzle based on electronics. Each word is connected to the word above and below by one or more letters although only one is usually shown as a clue. Each correct answer is worth 4 points; a perfect score is 100. It should prove fairly simple to get a high rating except perhaps for someone who thinks "Nome" is a unit of resistance, or that "sidebands" consist of hair growing in front of the ears. Pencil sharp? Comfortable? Then wire you waiting? Go!

1. Decrease in amplitude of a signal during transmission from one point to another.
2. A cgs electrostatic unit of charge.
3. Weakening of a material under repeated stress.
4. Freedom from changes due to varying voltage, temperature, etc.
5. Heavy-duty relay used to control electrical circuits.
6. Special type of electrostatically focused traveling-wave tube.
7. Photo or illustration transmitted by radio.
8. Opposition to the flow of alternating current.
9. The reciprocal of reluctance.
10. Condition of a circuit when no input signal is applied to it.
11. Position of one point in space with respect to another.
12. Not regulated by a fixed rule or law.
13. Showing different colors when object is viewed from several directions.
14. Glazed ceramic insulating material made from clay, quartz, and feldspar.
15. Pertaining to a very small particle.
16. To make or build.
17. An undesired low- or high-frequency signal in an electronic circuit.
18. Made up of distinct parts.
19. Term applied to material easily ignited and able to burn.
20. Pertaining to any frequency between 300 and 3000 megacycles.
21. Removing insulation from a wire or cable.
22. In a camera tube, the electrode to which the stored-charge image is capacitively coupled.
23. Electronic circuit for altering frequency response of an amplifier.
24. Imperfect, faulty, or incomplete.
25. Color band on a carbon resistor signifying the value of 9.

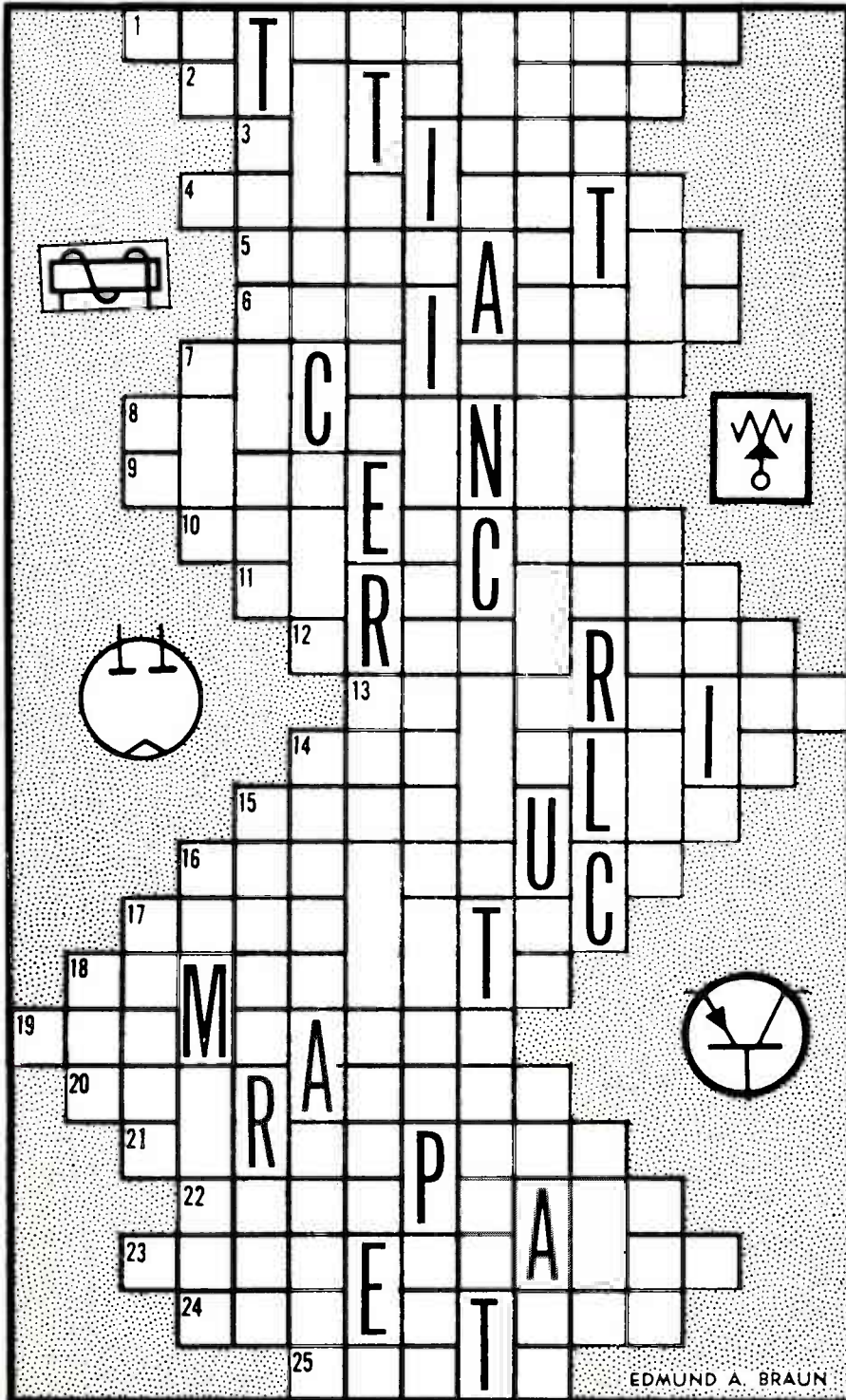

EDMUND A. BRAUN

The solution is on page 66.
WIRE YOU WAITING?

Customer Talk

By Terry L. Turner

Several truths are contained in this amusing story.

One important facet of television repairing is never taught in tech school, rarely written about, and often ignored by technicians. It is: "How To Talk With A Customer".

Now, you can't talk to a customer as though he is your best friend, because usually he isn't even friendly—especially after you hand him the repair bill. And, you can't insult him as you might an irritating in-law, either. A technician needs to develop a rapport with his customers that is between these two extremes.

Of course, you must vary this "customer talk" according to the situation.

When You Don't Know

This story illustrates one style of "customer talk". I was behind the TV set in a customer's home, and little beads of sweat were beginning to appear on my brow as I thought to myself, "I don't know what's wrong with this stupid television!"

Carefully, I peeked over the console at the customer. All 300 pounds of him was seated in his easy chair, and he resembled a combination of a sumo wrestler and Boris Karloff.

I steeled myself, and stepped from behind the TV console. "Uh... Mr. Jones, I'm afraid we've got a

bad problem here. I'll have to take it to the shop," I said, as I flashed a smile that rivalled the best Jimmy Carter can produce.

Mr. Jones stood up. And when that man stands up, he **really** stands up. "What's wrong?" he growled in a voice like thunder. In my mind, I could hear my mother telling me, "Remember, son, always tell the truth." But probably Mom never had been in this kind of a spot.

Should I tell the truth, or take the consequences? I chickened out, used double-talk, and hoped the customer didn't understand any-

continued on page 34



"I want it fixed right, even if it costs five dollars."



"Mrs. Johnson wants to know why her TV quit today, after you fixed it just last year."

RCA's FREE & EASY '77 Dealer Awards



FE-4118



FE-4104



FE-4117

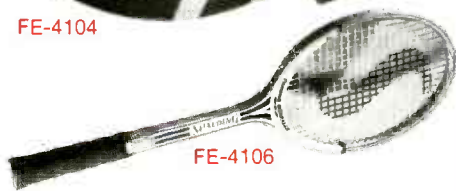

FE-4106



FE-4111



FE-4108



FE-4116



FE-4105



FE-4112

Customer Talk

continued from page 33

thing about electronics. "It looks like the TV has a bad framus, and you gazernflat needs adjusting."

Mr. Jones' eyes narrowed as he thought about my statement. Obviously, he didn't know whether or not to believe me; and if not, what to do about it. "Okay, but get it back as soon as you can," he said finally.

As I gathered up my equipment and carried the ailing TV to the truck, I thought, "I really didn't lie. Maybe it does have a bad framus, and maybe the gazernflat does need a little adjusting."

When The TV Is Not Ready

Another variation of "customer talk" is needed when you must explain why the set isn't ready at the promised time.

I was working busily at the bench, when I heard the front door open. "Uh-oh," I thought, "there's Mr. Smith and his B&W portable

isn't ready yet. Should I tell him the truth that the blond go-go dancer wanted her television fixed right away? What else could I do after she offered a front-row seat, the next time I was in the club? Probably Mr. Smith will understand. What red-blooded American boy wouldn't understand? But, wait a minute! He wasn't dressed that way when he brought in the TV. Where did that turned-around collar come from? **He's Reverend Smith!** Well, I can't lie to him; and I can't tell him the truth. I'll just not let him ask anything."

"Hello, Reverend Smith," I said, casually sauntering to the front of the store. When he started to reply, I practically yelled, "Lovely day, isn't it?" He slowly closed his mouth, and turned to look out of the window at the pouring rain. Hurriedly, I said, "Well, it's lovely if you're a duck. And speaking of ducks, have you seen our new line of color consoles?"

"Ducks!" said Reverend Smith.

"Um...yes, ducks. These sets shed problems like a duck sheds

water." I continued, "And pay no attention to that price tag. All of these sets are on sale today. I just haven't had time to put on the new price tags."



"Well to sum it up quickly, ma'am, you need everything but a new cabinet!"



When you think of receiving tubes, think RCA! When you think of dealer awards, think RCA "Free and Easy '77." Then get both from your local participating RCA tube distributor. Quality tubes and quality awards go hand in hand from RCA.

Free with your purchase of RCA Entertainment Receiving Tubes

Check out these 17 values; select the award you want; then visit your participating RCA distributor and find out how easily you can take home that award when you place your tube order.

- SPALDING "DRIBBLER" BASKETBALL — FE-4102 — Value: \$12.00 (Not Illustrated)
- SPALDING TENNIS CARRY-ALL — FE-4103 — Value: \$15.40 (Not Illustrated)
- WILSON PRO STAFF GOLF BALLS — FE-4118 — Value: \$15.75
- SPALDING REBEL FOOTBALL — FE-4104 — Value: \$17.00
- WATER PIK SHOWER MASSAGE — FE-4105 — Value: \$24.95
- SPALDING PANCHO GONZALES SIGNATURE RACKET — FE-4106 — Value: \$22.60
- PRESTO BURGER/2 — FE-4107 — Value: \$35.90
- GARCIA MITCHELL SPINNING COMBO - FE-4108 - Value - \$39.95
- SCHICK PRO JET-1200 STYLING DRYER - FE-4109 - Value: \$39.00
- SKIL DOUBLE INSULATED 2-SPEED JIG SAW — FE-4110 — Value: \$40.95 (Not Illustrated)
- TAYLOR AMERICAN EAGLE BINOCULARS — FE-4111 — Value: \$56.95
- SHEPHERD BALL-B-Q FAMILY SIZE GRILL — FE-4112 — Value: \$54.95
- HAZEL SAXONY 21" DUFFEL BAG — FE-4113 — Value: \$50.00
- ROCKWELL 16" HEDGE AND SHRUB TRIMMER — FE-4114 — Value: \$34.95
- SKIL MULTI-PURPOSE X-TRA TOOL — FE-4115 — Value: \$67.95
- OLIVETTI UNDERWOOD PORTABLE TYPEWRITER — FE-4116 — Value: \$79.50
- OLIVETTI "DIVISUMMA 32" ELECTRONIC PRINTING CALCULATOR — FE-4117 — Value: \$109.00

RCA Distributor & Special Products Division, Deptford, N.J. 08096

RCA Receiving Tubes

"Well, I suppose I could use a new TV."

"And this one is in color. You could watch all your favorite shows in color. And football games in color are..."

"Football games?"

I swear I heard 8 bars of the Hallelujah Chorus. "I think I've struck a nerve," I told myself. "Why, yes. It's better than seats on the 50-yard line. There's a big game this afternoon. I can deliver the TV before game time. And I believe there's a Billy Graham program on tonight."

By this time poor Reverend Smith was glassy-eyed, and staring into space. "I'll take it."

"Fine. I'll give you a good price for your old set, and deliver the new one this afternoon," I said as I led him to the door.

He walked through the door muttering, "Ducks?"

During A Call-Back

You should use a different kind of "customer talk" during call-backs. Here is one example.

I walked up the familiar path (it was familiar because I had been there just two days ago) to the house. The door opened before I could knock.

"Good morning, Mrs. Brown."

An icy stare greeted me. "The TV is still broken," she said with emphasis on the "still".

I eased through the small opening between the door jamb and Mrs. Brown. "I'm very sorry. I don't understand it. The TV worked fine in the shop after I repaired it."

"It's even worse now than when you took it away the other day."

I reviewed the repair in my mind. The problem had been with the horizontal sync, and I found a bad resistor. After I replaced the resistor, the TV worked fine during a long time test. "What's the problem, now?" I asked.

"It doesn't work at all. It's completely dead!"

While Mrs. Brown threatened me with everything from reporting me to her Senator for being an unscrupulous TV man to calling out

the National Guard, I pulled the console away from the wall.

Yes, you guessed it. The AC plug was on the floor, several inches from the outlet.

"Uh, Mrs. Brown?" I interrupted her, even though I was curious about how she was going to sue me for malpractice. "I believe I've found the trouble." I plugged in the cord, as she watched, and tuned in a fine picture.

I looked at her. She looked embarrassed. "I wonder how that happened?" she asked, sweetly.

Now, this is where you must decide whether to take justly-earned revenge, or let it pass. I recommend a simple, "That's all right. Mistakes happen." After all, she might want to buy a new TV someday.

The Last Word

As you can see from these examples, "customer talk" can cover a wide variety of situations. But remember this, talk gently to your customer. After all, **you'll have the last word, when you present the bill!** □

The Physics of Sound Applied to CB Radios

By Stephen R. Davis
President, Acoustic Fiber Sound Systems



Fig. A "KRIKET" Model 3035 external speaker and a CB transceiver were mounted in a car for listening and frequency-response tests.

To verify what our ears have been telling us all along about CB listening, researchers at Acoustic Fiber Sound Systems (makers of "Kriket" communications speakers) examined the physics of human speech and hearing, then tied in their findings with the effects on sound of a typical CB mobile environment, both naturally and electronically reproduced.

The results showed that a typical CB transceiver, when equipped with an external voice-communications speaker, definitely sounds much better.

Characteristics Of Human Speech

The average speech spectrum of a group of men measured from 300 Hz to 6 KHz. Vowel sounds fall in the frequencies between 300 Hz and 1,000 Hz, and are less vulnerable to attenuation than are consonant sounds, which are in the frequency range of 1,000 Hz to 5,000 Hz.

Because speech is dynamic, certain sounds are loud; others are soft. Consonants are softer and are more easily lost when background noise interferes. In a vehicle environment, consonant sounds are seriously impaired; and **they are the key to understandability with CB radios.**

Communications problems could be reduced if the human ear responded only to the frequencies inherent in human speech. Unfortunately, they do not.

Characteristics Of Human Hearing

The human ear can hear a much wider range of sound frequencies than the voice produces. From the threshold of hearing, 0 decibels (dB), the ear can tolerate an input up to three trillion times greater.

Figure 1 shows the frequency response for the ear between 20 Hz and 15 KHz. The ear is, however,

most keenly sensitive to frequencies in the range of 1,000 Hz to 5,000 Hz, where the consonant sounds are located.

The human ear, in conjunction with the brain, has the ability to analyze complex sounds received by the eardrum, then extract intelligent sound from noise. The ear-brain combination, however, is far from perfect.

Under some circumstances, **one sound can mask another**. The ear fails to differentiate certain sound components from others. This is called the masking effect, and it is measured by the amount of decibels that the threshold of audibility of a sound is raised by the presence of another masking sound.

Figure 2 illustrates the masking principle. It shows that it is harder to hear high frequency tones in a noisy environment, and that **the consonant sounds are more easily masked than are vowel sounds**.

The Importance Of Environment

Effective communication depends on the ability of the person speaking to articulate intelligent information; the environment to transmit sound; and, the listener to perceive this information.

A vehicle's environment can detract from voice intelligibility in several ways. Sound waves radiated directly between talker and listener represent the optimum communication condition. Sound waves reflected from environmental boundaries are adversely affected.

Soft surfaces, such as carpeting, tend to reduce high frequency levels; hard surfaces, such as a kick panel, create annoying reverberations.

Sound intensity reduces in proportion to the distance of the sound source from the sound receiver. Eliminating sound frequencies outside the human voice transmission

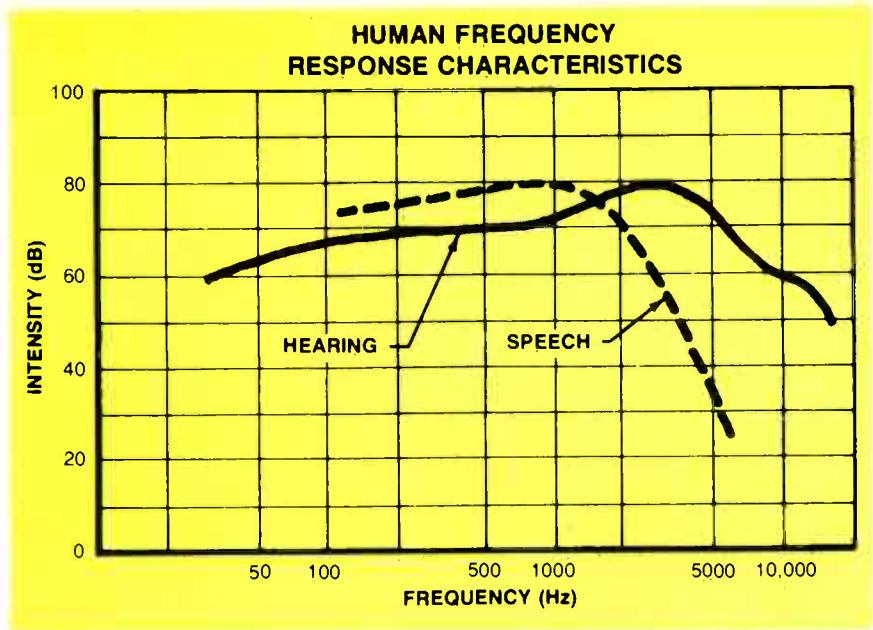

Fig. 1

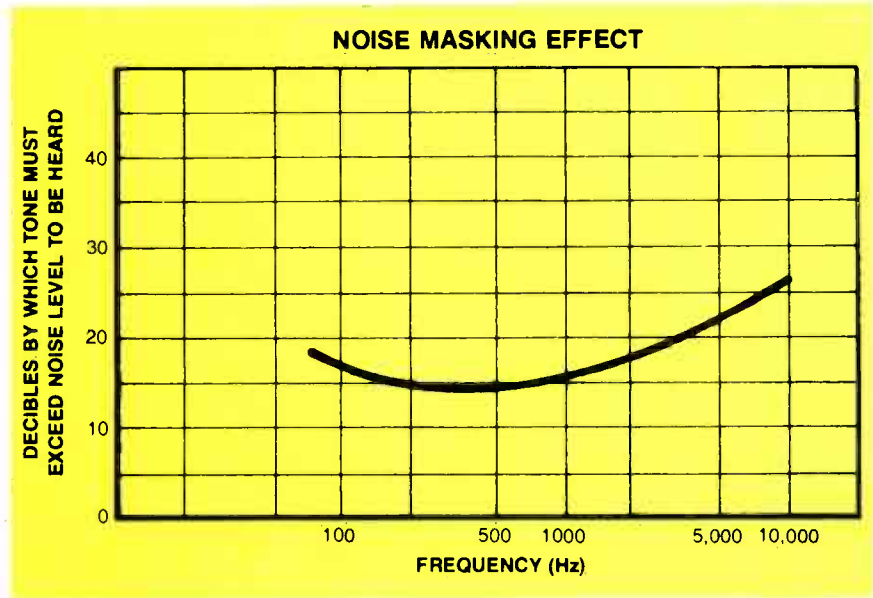

Fig. 2

frequencies—that is, below 300 Hz or above 6,000 Hz—tends to enhance voice intelligibility.

Effect Of Artificial Transducers

Electronic communications further alters the environmental characteristics which are between transmission and reception. A typical CB receiver reproduces a great deal of noise due to the large number of non-synchronized signals on the same frequency. Atmospheric noise mixes in to add to this masking effect.

Most CB transceivers have small-size speakers (dictated by the lack

of available space) which do not reproduce smoothly the full voice range. Transceiver speakers accentuate the frequencies in the vowel range, while diminishing the frequencies in the consonant (or maximum articulation) range.

By comparison, a properly-designed external speaker will reproduce the full range of frequencies generated by the human voice, accentuating those frequencies of the consonant sounds.

Transceivers are most often mounted under the dashboard. The speaker is commonly located on the underside, pointing directly down to

continued on page 38

Physics of Sound

continued from page 37

the vehicle's floor. This means the listener will be at least 120° from the front axis of the speakers, thus hearing attenuated consonants.

Tests In An Artificial Chamber

To demonstrate these various effects, a CB transceiver and external speaker were tested in an anechoic chamber, and also in an automobile environment.

Figure 3 shows that the transceiver speaker and external speaker performed comparably in the artificial anechoic environment, when both speakers were placed directly in front of (and one meter from) the chamber microphone. Even so, because of size and better acoustic design, the external speaker performed better, particularly in the 1,000 Hz to 5,000 Hz range, where the consonant sounds are.

However, neither transceiver nor external speaker ever is mounted in an artificial acoustic chamber. When mounted in a car, Figure 4 shows the dramatic decrease in the CB-transceiver speaker's performance.

Tests In An Automobile

In the car, the transceiver was mounted under the dash, the external speaker to its right, but pointed towards the driver. The test microphone was placed where the driver's head would be.

Note how closely the external speaker's frequency response in the car parallels its performance in the acoustic chamber. The destructive effects on sounds from the transceiver's speaker are clearly evident, because of: indirect sound bouncing from a soft, carpeted surface; speaker off-axis from the listener; and, smaller size and poorer acoustic design of the speaker.

Summary

Several important things now can be seen. Wide-range, smooth frequency reproduction (a desired attribute in high fidelity) is a detriment in a voice-reproduction system that is influenced by high ambient (masking) noise. The wider the frequency response beyond human voice parameters, the louder the unwanted noise which is clearly

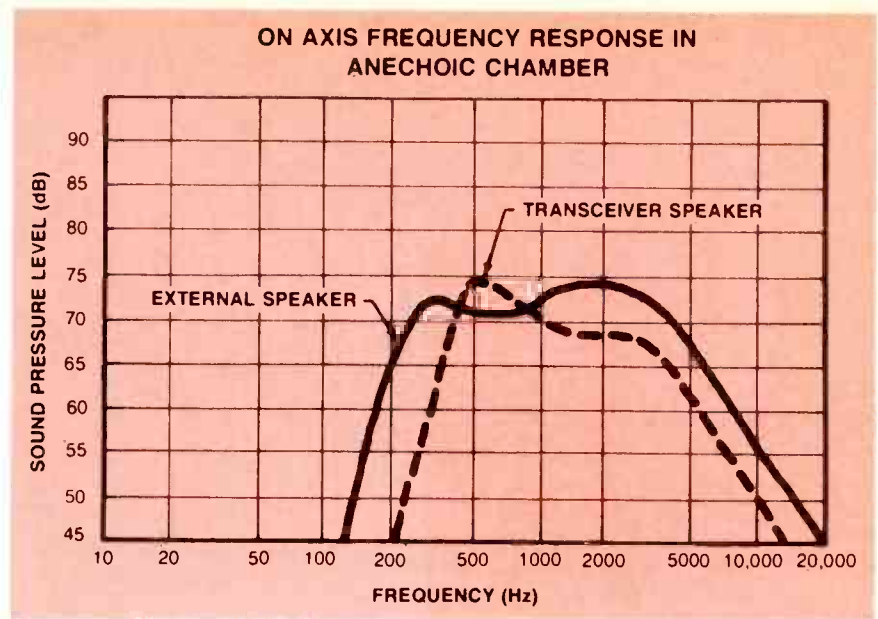

Fig. 3

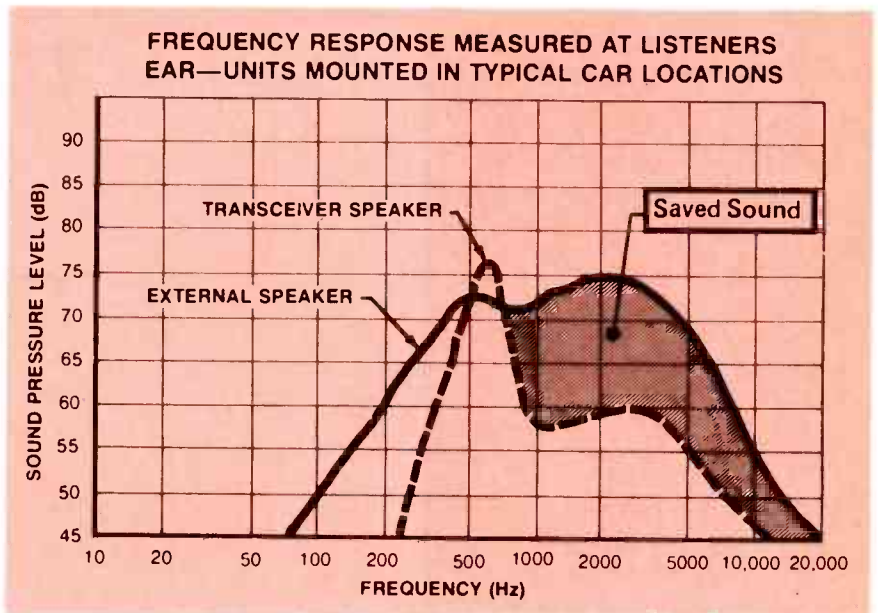

Fig. 4

All illustrations are by the courtesy of Acoustic Fiber Sound Systems.

perceptible to the ear. This is why switching to CB reception through a music speaker is so disappointing.

Secondly, a well-designed CB external speaker should and does limit its frequency response to those of the human voice, while retaining a loud, even frequency response within the voice range. The speaker inside a CB transceiver does not.

Thirdly, it is better to have the speaker nearer the ear. External speakers, because of size and design flexibility, can be mounted right next to the driver, particularly in a high-ambient noise environment, such as the cab of a diesel truck.

All links in the communication chain—the person talking, the environment both physical and electronic between the talker and listener, and finally, the listener himself—must be considered in a study such as this. Proper optimizations have been made.

Severe degradations of intelligibility are introduced by the internal CB transceiver speaker in a typical automobile installation. The absorption and reflection of sound waves can be reduced greatly, and the enjoyment of CB listening enhanced, by the addition of a properly-designed and correctly-positioned external speaker. □

BE COMPETITIVE



40 CHANNEL CAPABILITY
with exclusive
Percent Off Channel
direct readout
(Patent Pending)

\$975

All cables included

With Everything You Need for Fast CB Service in One Lower Priced, Compact Instrument . . .

AVOID TIME-WASTING MULTIPLE INSTRUMENTS AND CONFUSING CABLE SYSTEMS. GET AT THE PROBLEM IN A JIFFY WITH THE

SENCORE CB42 AUTOMATIC CB ANALYZER

It's a CB Profit Center All in One Handsome Instrument

The CB service market is growing and more "on the ball" technicians are getting into the act every day. Competition for the CB business is getting tougher and you'll want to be sure you can compete. Knowledge alone won't be enough. You'll want to get ahead by simplifying your work to get the most jobs out with the least effort. You'll want to concentrate on your troubleshooting and not fiddle with 15 cable connections and 28 knobs on different instruments. So you will want to get an instrument that takes you from antenna input to speaker, and from mike to antenna load in one neat package.

To top that off, the complete CB42 is hundreds of dollars below the nearest competition, and thousands below most. We've got our competition beat, and you'll beat your competition, too, by saving these six ways with this CB42 Profit Center.

\$AVE ON REPAIR TIME:

One simplified tester in a single case saves time on every test on any CB that comes in your door, including Single Sideband sets; you won't even need a scope.

\$AVE ON READOUT TIME:

One direct-reading digital readout saves interpretation time and reading errors. You'll know the CB's frequency, generator frequency, Percent Off-Channel, positive/negative modulation and distortion, RF output, and audio output with a simple flick of a switch. Only the CB42 is this simple and complete.

\$AVE ON CHANNEL CHECKING:

Simply rotate the CB42 and CB selectors through all 40 channels and read "percent off center frequency" on the direct-reading digital meter (.005% FCC maximum deviation) in less than two minutes for all 40 channels.

\$AVE ON TIME CONSUMING CONNECTIONS:

Three cables, provided with your CB42, do the entire job; audio cable, transmitter cable, and receiver cable.

\$AVE ON ANNOYING HOWL:

Why get a screwdriver in the back from the guy next to you, when you can substitute for that annoying speaker howl? Just plug the built-in, non-grounded speaker sub cable into the transceiver and quietly monitor the audio output on the meter.

\$AVE ON BENCH SPACE:

The CB42 takes less than one-third the bench space of other equipment. You can even take it to the field with you, for on-the-spot mobile checks, since it is also 12 Volt battery powered.



SENCORE

3200 Sencore Drive, Sioux Falls, South Dakota 57107
Phone (605)339-0100

VALUE LEADERS IN RADIO-TV, 2 WAY AND MRO INSTRUMENTS

Troubleshooting Tips For Admiral Vertical

By Homer L. Davidson

New solid-state circuits require better servicing techniques and a thorough knowledge of the theory behind the circuits. Both practical tips and circuit operation of Admiral vertical sweep are included.

A vertical module (M600 in Figure 1) of the Admiral M24 and M25 chassis contains the sync-inverter, blanker, switch (oscillator), pre-driver, and driver stages. Two power transistors, mounted on a large flat heat sink, complete the solid-state vertical system.

The same circuits are used in the M30 chassis, and similar ones are in other Admiral models. Therefore, the suggestions can be applied to them, also.

Unlike tube circuits, where poor vertical linearity and creeping height are very common, transistor-sweep circuits seldom produce poor

Fig. 1 Most of the vertical-sweep components of the Admiral M24 and M25 chassis are mounted on the M600 module. The output transistors and associated resistors are located on the large flat heat sink.



tical

ge 41

for resistance and
ns of having been
ce any that are

f servicing can be
i the home during
ever, if a vertical
ins, the chassis or
en to the shop for
i the bench.

The Bench

to the vertical-
ome means of
on a picture tube
e. A scope can be
ts of troubles in
scope waveforms
nough to prove
linearity.
iral circuit (see
sample of the
ze to the oscilla-
sistor. Without
nk, neither oscil-

Circuit analysis

Figure 5 show
wiring of module
plete complementa
and blocks to rep
vergence, pincus
circuits. Remember
solid-state equiva
balanced multivibra
two-tube versions u
solid-state models.
there is a large c
oscillation cannot

lation nor sweep c
of approximatel
pedance is needed

If you have a
then operate the
Otherwise, bring
receiver, place the
the padded cabin
tension cables, a
without complicat
the extension for
picture tube will b
of the picture, but
horizontal sweeps



Fig. 4 After you install replacement output transistors, look at the bottom of the sockets to be certain the pins come through the sockets correctly.

inversion is the reason it's included, for after the R607/C603 and R609/C605 integrator network, R609 and R613 reduce the sync amplitude.

Immediately following the start of each vertical oscillation, Q604's C/E path shorts out all of the vertical sync. This is done to improve the immunity against noise, which might cause double triggering.

Of course, if Q604 develops a collector-to-emitter short, the resulting loss of sync will prevent any vertical locking. If you suspect Q604, either remove it and notice if the locking returns, or check it in-circuit. Except under certain noise conditions, the removal of Q604 makes no noticeable change of operation.

Oscillator

Most schematics call Q601 a "switch". Of course, it does function as a voltage-controlled switch, but so does every device used as a Class-"C" oscillator. I favor calling

it the "oscillator", in the interests of clarity, although that is only a half-truth; actually it is only half of a multivibrator.

Positive feedback from the output transistors is reduced in amplitude and filtered by R620 and C614, then it goes through C604, R612, and C606 to the base of Q601. C606 and R610/R146 (hold control) are the time-constant components that determine the frequency of the oscillation.

Forward bias for the base of Q601 comes through the vertical-hold control and R619. Any open between base and B+ stops the oscillation. This is a good tip to remember. For example, a loose connection at P601-2 or P600-2 could kill the vertical sweep.

At the collector of Q601, the "oscillator", the waveform is a tiny sawtooth and a large pulse for each cycle. Two different kinds of negative feedback are applied to the collector signal. The principal feed-

continued on page 44



TUN-O-POWER OUTLASTS 3 CANS OF ORDINARY TUNER SPRAY



**AND TUN-O-POWER
KEEPS TUNERS WORKING
BETTER, LONGER!**

A one second blast of TUN-O-POWER has more cleaning and lubricating power than a three to five second blast of any ordinary tuner spray. That's why one can of TUN-O-POWER outlasts three cans of ordinary spray.

**DRY TEFLON
MAKES THE DIFFERENCE**

Economy isn't TUN-O-POWER's only advantage. It works better too. Ordinary tuner cleaner-lubricants are made with petroleum based grease. Grease attracts dust and gunks up.

TUN-O-POWER is made with dry TEFLON. It keeps contacts clean and corrosion-free, while maintaining smooth-as-silk detent action.

Try it. You'll love it.

**CHEMTRONICS
INCORPORATED**

45 HOFFMAN AVE., HAUPPAUGE, N.Y. 11787 • (516) 582-3322

For More Details Circle (12) on Reply Card

an occur. A yoke is broken at any point. The base of Q601 is the equivalent of the motor grid, and the emitter Q101 takes the

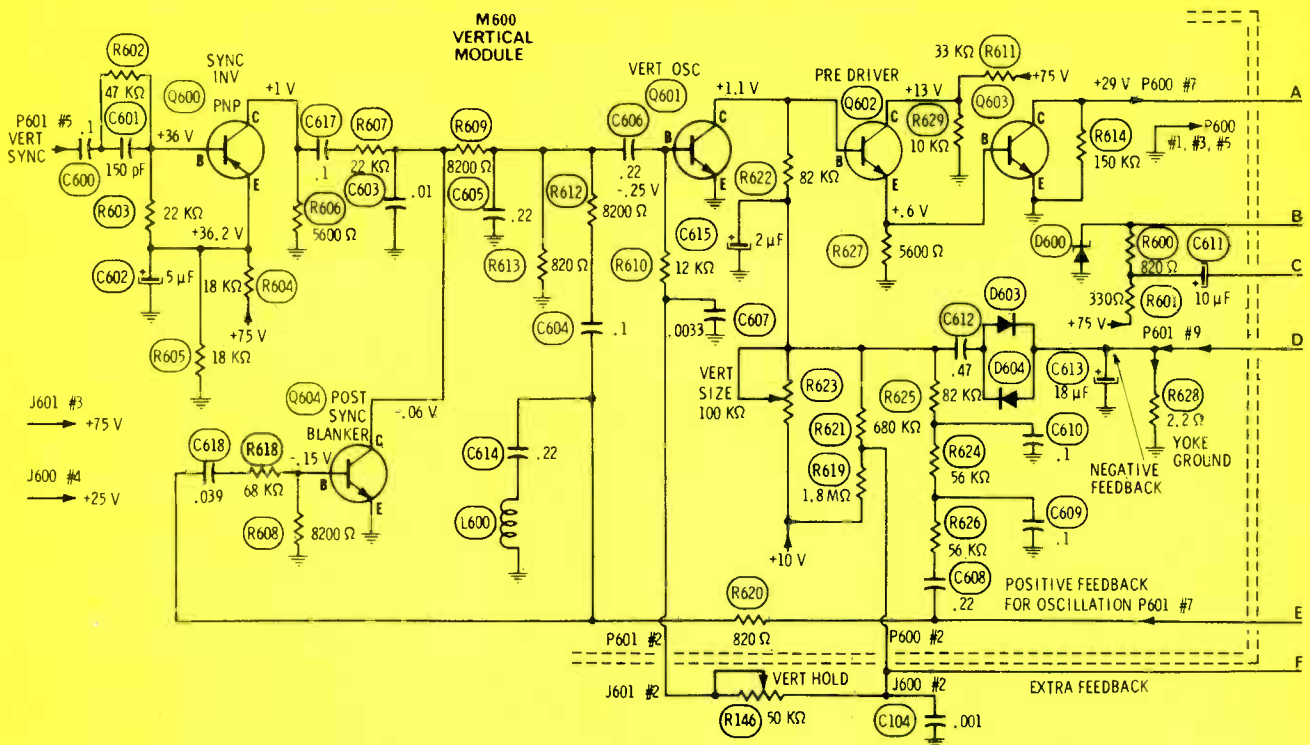

Admiral Vertical

continued from page 43

back comes from the yoke current that goes to ground through R628. The voltage drop across R628 travels through the front-to-back diodes, D603 and D604, through C612, and R622 to the collector of Q601. This feedback corrects for any moderate non-linearity (a linearity control is not necessary), and the yoke **current** is a perfect sawtooth waveform.

There's just one problem: the linearity is **too** perfect! Sweep increases at the edges of any wide-angle picture tube. Therefore, without some correction, this linear sawtooth of yoke current would produce a slight spreading at the top and bottom of the raster. The purpose of the filter (that's made up of C608, C609, C610, R626, R624, and R625) is to flatten the ends of the sawtooth, thus minimizing the spread of linearity at top and bottom. In fact, it is called an "S" filter, because that's the kind of distortion it gives to the sloping part of the sawtooth during trace time, although the small amount of

flattening is difficult to see on a scope (Figure 6).

Direct coupling

The four stages between C606 at the base of Q601 and C1011 at the output are direct coupled. Therefore, any component defect that changes a DC voltage in one stage also will change radically all of the DC voltages downstream. In fact, many defects produce wrong voltages in stages ahead of the problem, because the amplitude or frequency of oscillation is affected seriously.

None of the transistors has a steady bias, but instead the bias has pulses mixed with it. So, the amount of DC-voltage change depends on whether the change is triggered by a loss of AC signal, or by too much or too little transistor current.

For example, a defect that removes the positive-feedback signal from C604, probably would not change the DC voltages by any large amount (except the base of Q601 would become positive with a steady forward bias).

By contrast, an open in R610,

R146, or the connectors would remove all DC forward bias from Q601. This would increase the forward bias of Q602 and Q603, but decrease the bias of output transistor Q100. Therefore, the vertical output (at the input of C1011) would exhibit a near-zero DC voltage.

Tracing by scope

Positive feedback to make the sweep circuit oscillate comes from the output of the convergence wiring. If insufficient signal is fed from there back to the base of Q601, there can be no sweep waveform. And without a waveform, the scope will not be an effective choice of test equipment. When the TV screen shows absolutely no deflection, usually no significant waveforms can be found anywhere in the vertical circuit. The one exception is when a vertical-yoke coil is open.

In-circuit transistor tests

An in-circuit transistor tester should identify all open transistors, and most shorted ones. Where the circuit impedances are low, or when

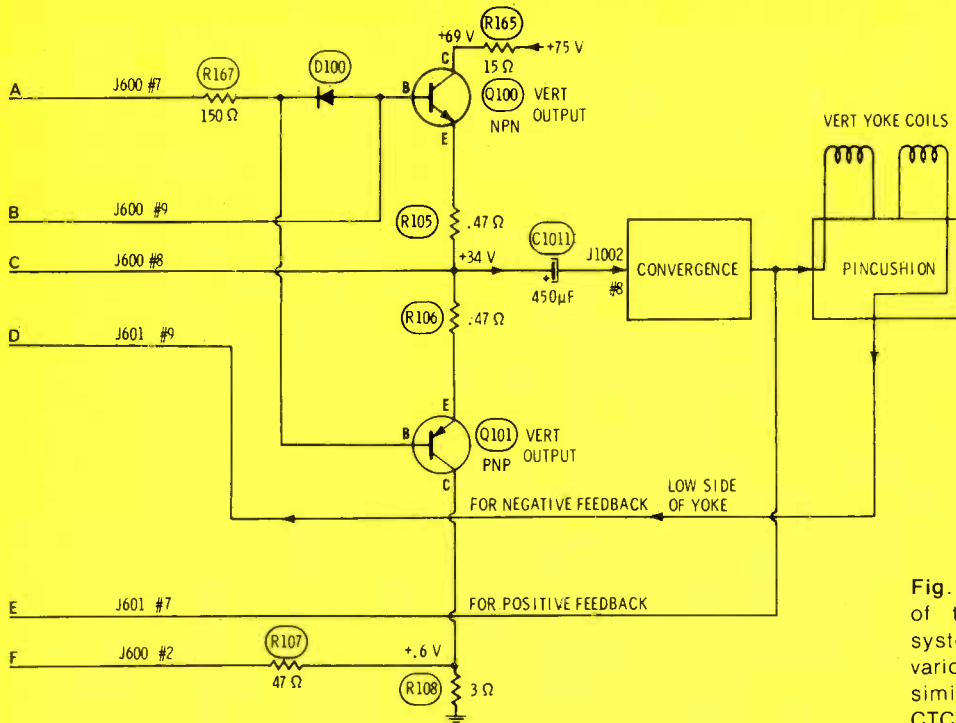

Fig. 5 This is the complete schematic of the Admiral M24 vertical-sweep system (Photofact 1436-1), with the various feedback paths labelled. A similar circuit is used in the RCA CTC58 (Photofact 1428-2). Refer to **Electronic Servicing** for December, 1976 for more tips.

you suspect leakage, remove the transistors for a more accurate test, out-of-circuit.

Sometimes the flat TO-220 output transistors will "pop on" when the base or emitter leads are moved. Probably this is caused by broken leads or bad connections inside the transistor. If you're sure the transistor intermittently becomes open, it's best to replace

both outputs at the same time.

Supply voltages

Always check for the proper supply voltages at the module connectors. The +75-volt supply at pin 3 of J601 comes from the main source, as shown in Figure 2.

However, the +25-volt supply at pin 4 of J600 is produced by

(see Figure 7).

In addition, the voltages found at the various connector pins in a normally-operating receiver are listed in Figure 8. These will serve as a general guide for your troubleshooting-by-voltages.

Output voltages

Because the two output transistors
continued on page 46

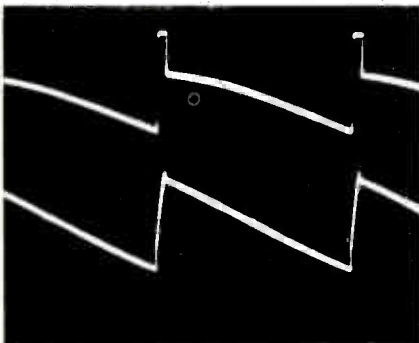

Fig. 6 The correct sweep waveforms are backwards from many other solid-state models. Top trace is found at the collector of Q603, and the output from Q100 and Q101. Below is the sawtooth of yoke current at P601 pin 9.

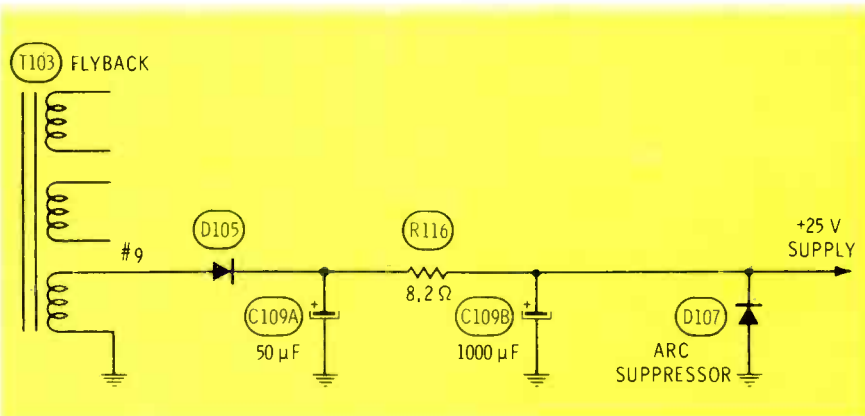

Fig. 7 Power for the +25-volt DC supply comes from the horizontal-sweep pulses at the flyback. When there is no vertical sweep, try the audio volume. A loss of the +25-volt supply will eliminate both. Diode D107 apparently is included as an arc suppressor, clipping off any negative peaks.

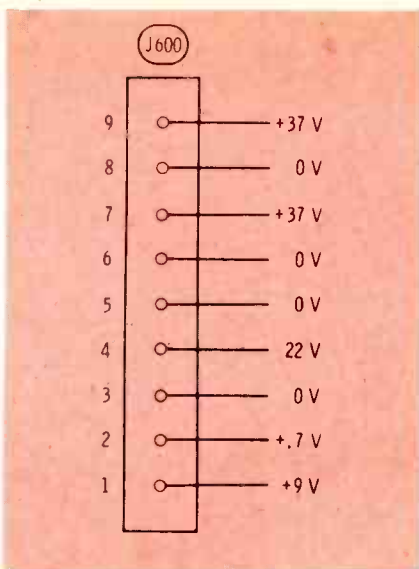

Fig. 8 These are the DC voltages measured in one normally-operating Admiral chassis. Use them to guide your own troubleshooting.

Admiral Vertical

continued from page 45

tors are at the end of four direct-coupled stages, the DC voltages there can be used as a sensitive indicator of the vertical-sweep operation.

With complementary-symmetry power stages in either audio amplifiers or vertical-sweep systems, the output from the emitters normally is approximately half of the supply voltage or voltages. If the collector of Q101 were furnished with a minus voltage, and the collector of Q100 supplied with an equal positive voltage, the output at the emitters would be approximately zero (halfway between the two supply voltages).

In the Admiral circuit that has a single positive supply, the output DC voltage from the emitters is approximately half of the supply voltage.

This test point can be found easily and quickly, and you should check the DC voltage as one of the first steps. Afterwards, the base and emitter voltages, and the various emitter and collector resistors of Q100 and Q101 should be tested.

Resistors R165, R105, R106, and R108 have a secondary function as fuses, and will burn open from dead shorts in the output transistors. Always check these resistors when you replace the transistors.

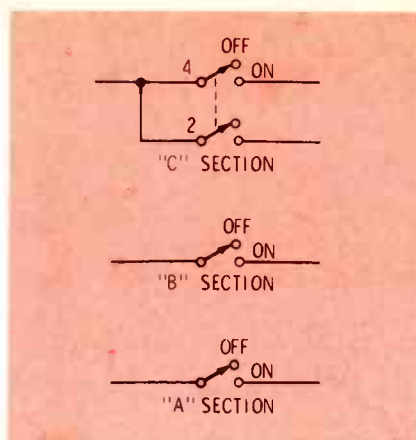

Fig. 9 Some versions of the Admiral M24 and M25 include this "instant play" switch. The "A" and "B" sections open the AC to the bridge rectifiers, when the power switch is turned "off". If one section fails to close in the "on" position, resistor R104 in Figure 2 probably will burn.

All of the normal heavy current to operate the output transistors comes through transistor Q100. So, if R165, Q100, or R105 is open, the DC voltage at the input of C1011 will be very low. On the other hand, an open in R106, Q101, or R108 (when the Q100 side is okay) raises the DC output voltage high above normal.

Thermal intermittents

Suspect an intermittent transistor when the vertical sweep stops after several minutes of operation. Typically, any poor connection inside a transistor can become sensitive to heat, opening and closing like a thermostat.

Wait until the height disappears, then carefully spray canned coolant on each transistor in turn. Be certain the spray touched only one at a time, because sometimes merely a tiny amount of spray is enough to trigger a change.

When you reach the offending transistor, the height usually returns immediately. To prove this result is not accidental, warm the transistor slightly (using a heat source with a flexible nozzle, or a soldering iron held against the transistor case for a few seconds), and try the spray again when the height is eliminated. It's best to repeat the heating and cooling tests several times to obtain a trustworthy result.

Sweep versus sound

Low-level stages in both the sound circuit and the vertical module operate from the same +25-volt supply (see Figure 7). Therefore, when the main complaint is about the lack of vertical height, try the volume control to determine whether or not the sound is there.

Incidentally, diode D105 is mounted on the flyback transformer, T103.

Add a resistor

Early production chassis did not have R167 (Figure 5), which is in series with the base signal to Q100 and Q101. When you find the output transistors are defective, check for R167, and add one if it isn't there, before you replace the transistors. R167 is a 150-ohm ½-watt type.

Hot resistor, but no short

If R104 of Figure 2 overheats, a defect of the vertical module or the output transistors might be overloading the +75-volt supply.

However, before you spend too much time checking the vertical, test the continuity of switch S105, looking for an open section. This switch is for the "instant play" feature, and not all versions have it. As shown in Figure 9, there are four sections in three switches. Sections "A" and "B" open the secondary winding of T100 power transformer. If one of these fails to close when the set is turned on, the circuit of the rectifiers is changed, causing excessive current through R104. Make sure the AC reaches both inputs of the bridge rectifier when the power is on.

Summary

Because the vertical sweep is a closed-loop circuit, no one basic test can be recommended as the best. Instead you must select scope waveforms, DC voltages, resistance measurements, and in-circuit or out-of-circuit checking of transistors. Perhaps you will need to use all of these methods in sequence, depending on the individual defect. That's why we have emphasized the circuit operation. When you understand the theory, and the limitations of these tests, you should be able to find any defect. □

RC Circuits

Author: Rufus P. Turner

Publisher: Howard W. Sams & Co., Inc., Indianapolis, Indiana 46268

Size: 96 pages

Price: \$4.95 paperback

Resistance/capacitance (RC) circuits have a multitude of uses, such as timing, filtering, phase shifting, and waveshaping. Therefore, a thorough knowledge of RC circuits is valuable for any kind of electronic troubleshooting. The only chapter about fundamentals covers the AC cycle rate-of-change, phase relationships, the basic natures of resistors and capacitors, resistors and capacitors in series and parallel, time constant and its effects on waveforms, and the attenuation from RC networks. Other chapters describe in detail how many practical RC circuits operate. Many illustrations are provided, with a minimum of mathematics.

Contents: Fundamental Theory; Phase-Shift Circuits; Timing Circuits; Filter Circuits; Bridges and Null Networks; Miscellaneous Circuits; 1000-Hz Reactance of Stock Capacitors; Time Constants of Common RC Combinations; Conversion Factors for RC Circuits; Index.

Frequency and Its Measurement

Author: Rufus P. Turner

Publisher: Howard W. Sams & Co., Inc., Indianapolis, Indiana 46268

Size: 96 pages

Price: \$3.95 paperback

Technicians who know practical electronics should find the additional information (not usually provided in electronics textbooks) about frequency and its measurement to be extremely helpful. Following an introductory chapter on frequency and frequency measurements, the text explains audio-frequency measurements, such as the beat-note method, reed-type frequency meter, and analog and digital frequency meters. Radio-frequency measurements also are covered. Precautions such as lead length, grounding, bypassing, shielding, and harmonics are discussed. The practical presentation is essentially nonmathematical.

Contents: Fundamentals; Audio-Frequency Measurement; Radio-Frequency Measurement; Frequency Standards; Frequency and Wavelength Conversion Factors; Frequency-Wavelength Formulas; Frequency-Period Formulas; Abbreviations; Index.

Big little DMM.

You get bench-size accuracy, and long-term stability and performance, with our new, hand-held, 3½-digit VOM. It's in a class by itself.

- Highly readable, field-effect LCD
- Semi-autoranging
- Fast, accurate response
- Small size, battery operated (ac optional)
- Low power consumption
- Built-in overload protection

See it at your VIZ distributor.

**VIZ Test
Instruments Group**

of VIZ Mfg. Co.

335 E. Price St., Phila., PA 19144

© VIZ
6826

**WD-751A
\$179.00**

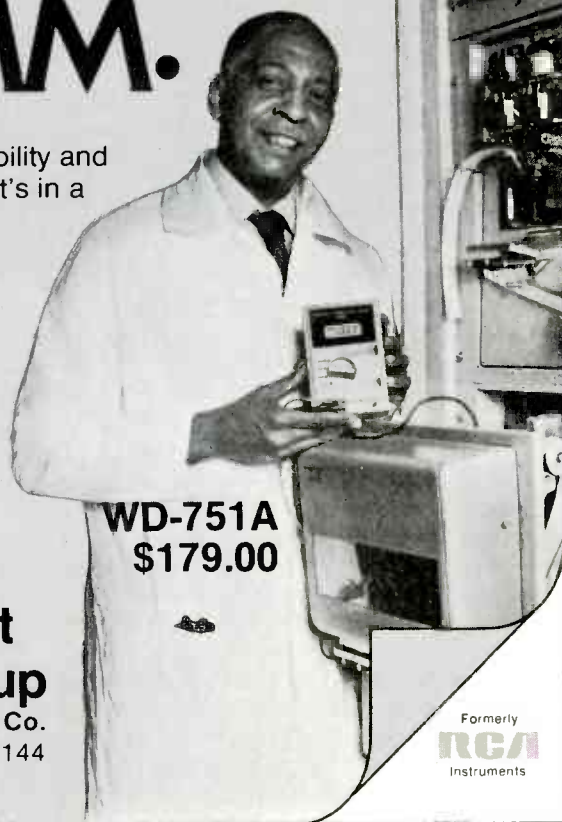

Formerly
RCA
Instruments

For More Details Circle (13) on Reply Card

Towers...Rx For Fringe Areas



By Bert Wolf, Vice-President of Sales
Jerrold Electronics Corporation

Towers are "just what the doctor ordered" for better TV reception in weak-signal fringe areas.

Fig. 1 For fringe-area TV reception, a tower installation with powerful antenna and preamplifier is recommended. If the stations are located in different directions, a rotor should be added; or several antennas could be installed.

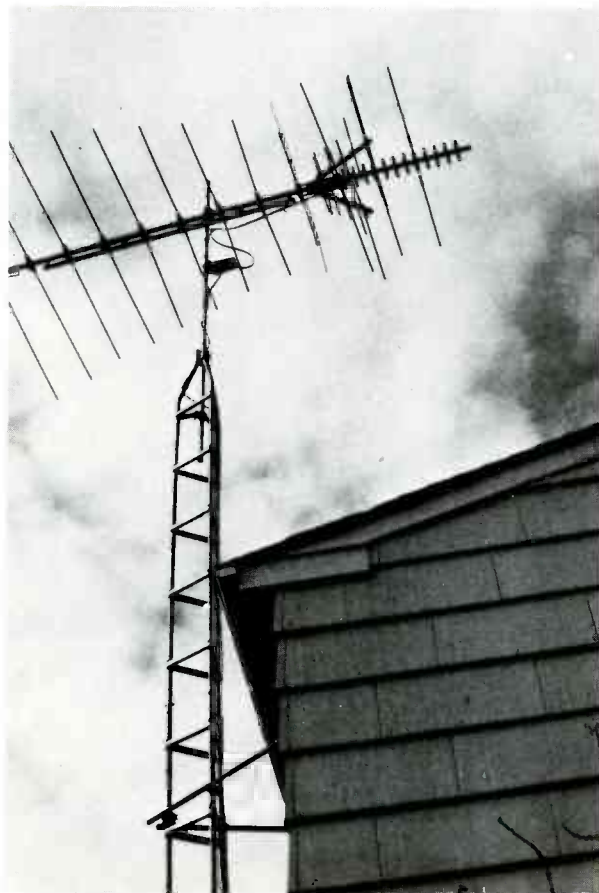

In fringe reception areas, you have to work hard for every microvolt of TV signal. Three things are essential: the antenna must have very high gain; a low-noise mast-mounted preamplifier is needed; and, the antenna should be mounted up high.



Fig. 2 Various sections of the tower should be assembled on the ground.



Fig. 3 The base plate is bolted securely.

As a general rule, doubling the antenna height also doubles the amount of VHF signal, while the same doubling quadruples UHF signal pickup.

Height Versus Antenna Gain

To appreciate the advantage of antenna height, we need to compare the increase of signal, obtained from raising the antenna, to the stronger signal produced by a larger antenna or a preamp.

All antennas do not have the same gain, but it depends on the design, including the number of elements. Relative to the signal from a standard dipole, for example, a Jerrold Model VU-931S antenna (with 9 VHF elements) provides about 7-dB of gain for the high-VHF band. By comparison, the VU-934S (16 VHF elements) gives about 12 dB, and Model VU-937S (26 VHF elements) furnishes about 13.5 dBs.

Therefore, the difference in antenna gain between the 7-element and the 26-element types is about 6.5 dB. Remember that 6-dB gain is double the signal voltage.

Height Versus Antenna

A Model VU-931 at 60 feet above ground level generally gives the same high-band VHF signal strength as will a VU-937S at 30 feet above ground.

These figures are for open air, without special obstructions. In some locations, a higher antenna location provides even stronger signals, because the terrain distorts the normal concentrations of signal.

For UHF reception, height is even more important. The VU-937S provides about 5 dB more UHF gain than does VU-931S. Doubling the antenna height increases UHF gain by about 12 dB. Therefore, a VU-931S at 60 feet can provide about 7 dB more than a VU-937S at 30 feet.

Preamp Gain

A well-designed VHF preamp might produce a gain of 20 dB, or more. However, gain from an antenna (or from increased antenna height) is far more desirable than preamp gain.

continued on page 50



AUTOMATIC STAPLE GUNS

CUT WIRE & CABLE INSTALLATION COSTS

without cutting into insulation!

SAFE! Grooved Guide positions wire for proper staple envelopment! Grooved Driving Blade stops staple at right depth of penetration to prevent cutting into wire or cable insulation!

No. T-18—Fits wires up to 3/16" in diameter.

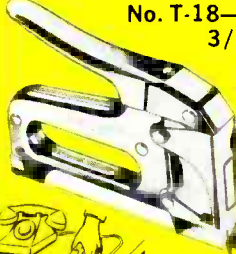

BELL, TELEPHONE, THERMOSTAT, INTERCOM, BURGLAR ALARM
and other low voltage wiring.

Uses T-18 staples with 3/16" round crown in 3/8" and 7/16" leg lengths.

No. T-25—Fits wires up to 1/4" in diameter.

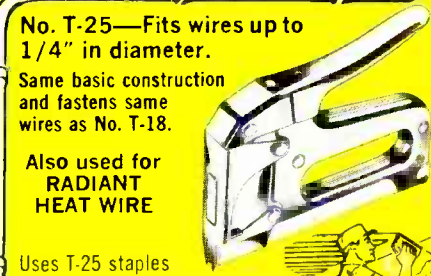

Same basic construction and fastens same wires as No. T-18.

Also used for RADIANT HEAT WIRE

Uses T-25 staples with 1/4" round crown in 9/32", 3/8", 7/16" and 9/16" leg lengths.

NEW! Intermediate

No. T-37—Fits wires and cables up to 5/16" in diameter.

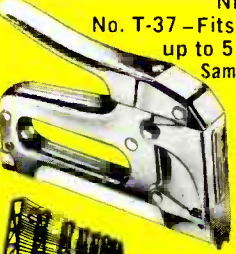

Same basic construction as Nos. T-18 & T-25.

Also used for CATV and DRIVE RINGS in stringing wires.

Uses T-37 staples with 5/16" round crown in 3/8", 1/2" and 9/16" leg lengths.

No. T-75—Fits wires and cables up to 1/2" in diameter.

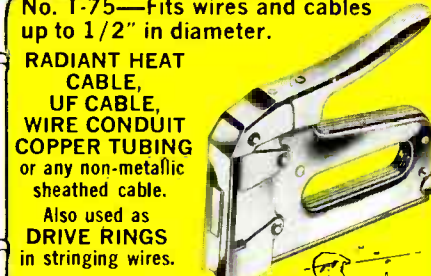

RADIANT HEAT CABLE, UF CABLE, WIRE CONDUIT COPPER TUBING or any non-metallic sheathed cable.

Also used as DRIVE RINGS in stringing wires.

Uses T-75 staples with 1/2" flat crown in 9/16", 5/8" and 7/8" leg lengths.

ARROW FASTENER COMPANY INC.

271 Mayhill Street, Saddle Brook, N. J. 07663

Towers

continued from page 49

Unfortunately, as each preamp equally amplifies the signal and the incoming noise, it also adds a tiny amount of internal noise. That's why a preamp can improve the signal-to-noise (SNR) only by the amount of attenuation in the downlead between the antenna and the TV receiver.

Typical signal loss in the downlead is about 3 dB for Channel 13. So, if you use a mast-mounted preamp, the SNR is improved by about 3 dB, compared to a non-amplified system. This is true, regardless of the preamp gain (provided the gain exceeds 3 dB, and the SNR equals that of the TV receiver).

Many of the new preamps have a better SNR than the TV sets have. In such cases, the signal-to-noise ratio will be improved even more.

But, regardless of these small advantages, extra gain by a better antenna or a higher location of the antenna provides superior SNR, compared to equal gain from a preamp.

Use all three

In fringe areas, where all signals are weak, you are not forced to choose between antenna gain, height gain, or preamp gain; **use all three!** Install a large antenna, a good preamp, and raise the antenna as high as possible.

Tower Installations

Probably the best way of getting the antenna up high is with a tower. A large system with a heavy antenna, mast, and guy wires might damage a roof severely. The damage could cost more than a tower. What's more, guy wires tend to "sing" in high winds.

On the other hand, a tower prevents any roof damage, while keeping the antenna away from corrosive fumes from the chimney. Further, a tower can be climbed, allowing the addition later of a rotator, or repair work on the antenna, without taking down the complete system.

A typical fringe-area installation is pictured in Figure 1. It includes a Jerrold VU-936S antenna and a high-gain preamplifier mounted on a 30-foot tower.

This antenna system was in-



Fig. 4 The mast, preamplifier, and antenna are assembled and attached to the tower.



Fig. 5 Coax cable is not sensitive to metal near it, so standoffs are not necessary. However, the coax should be secured, perhaps by layers of plastic tape, to the mast and the tower, thus preventing it from being moved by the wind.

stalled in less than three hours by two men.

First, the area where the tower base-plate was to rest was cleared of grass and levelled. The tower was assembled on the ground (Figure 2), the base plate was added to the tower foot (Figure 3), and finally the antenna, preamp, and mast were attached to the top of the tower (Figure 4). The coax downlead was connected to the antenna and the preamp, as shown in Figure 5, and then taped to one of the legs of the tower.

Next, a 3-foot length of 2X4

lumber was prepared with nails and lag screws (Figure 6), and attached to the soffit of the house (Figure 7).

Raising the tower

After the tower was assembled completely on the ground, one man used a ladder to climb to the roof. He lifted the top end of the tower with a rope, and the man on the ground pushed until the tower rested against the side of the house, as pictured in Figure 8. By using a loose safety rope to keep the tower from falling, the men positioned the tower at the approximate location.



Fig. 6 Prepare the 2X4 with nails and lag screws for mounting under the eaves.



Fig. 7 Secure the 2X4 to the house, using the nails and lag screws.

Then, they attached the tower bracket to tower and 2X4 (Figure 9).

Finally, the tower was moved into a true vertical position by taps from a sledge hammer against the base, while the men checked with a level (Figure 10).

Figure 11 shows the last step. After the tower was completely vertical, it was secured by three base stubs, which were driven by a sledge hammer into the ground at an angle.

Installation By One Man

It is not excessively difficult for

one man to erect a tower of this type, but the method must be changed slightly. The antenna and mast can't be attached to the tower on the ground. Instead, the tower is assembled on the ground and placed near the house, with the base pointing away, where it can be raised to the roof easily.

After he climbs to the roof, the installer uses a rope to pull up the top of the tower until it rests on the roof. Then, he keeps it from falling by roping it to the house bracket. (A 30-foot tower without antenna and mast can be managed by one



Fig. 8 The man on the roof lifted the assembled mast and antenna, connected a safety rope to prevent it from falling accidentally, and both men positioned the tower approximately where it should go.

man.) Next, the installer attaches the mast, antenna, and preamp to the top of the tower, pulls the tower to an upright position, secures it with the house bracket, and proceeds as previously described for the two-man installation.

If the tower is higher than 30-foot, two or three sections can be assembled on the ground and fastened to the house bracket. Then the base plate can be secured in the right location. At this point, the tower is safe for climbing. While using a safety belt, you can climb the tower, hook the next tower section by using a rope, raise and place the section on top of the tower, and fasten it into place. Sections can be added one at a time this way, until the tower is complete.

Comments

Removing the booster or pre-amplifier, and replacing the lost
continued on page 54

PUT YOUR FINGER ON THE TRUTH

It's the one and only flat-rate increment system that gives you the great feeling of pricing every job right. A system that treats both customer and shop owner fairly. Fast finger-tabs in both editions: **6x9 Hard Cover**, steel ring-bound - \$19.95 ea. post pd.

Or **The Satellite Edition** for pocket sized convenience - \$16.95 ea. post pd.

New **Computerized Parts Pricing** manual lists over 3,500 most-used parts - \$75 initial set-up plus \$10 per copy.



tv & radio
**tech's guide
to pricing**

P.O. Box 5234
Lincoln, NE 68505

Nebr. residents
add sales tax

sperry tech inc. (No. editions)

My check enclosed _____
 BankAmericard _____ Exp. _____
 Master Charge _____ Exp. _____
 Name _____
 Co. _____
 Address _____
 City _____
 State _____ Zip _____

For More Details Circle (17) on Reply Card

Convention OF ELECTRONIC SERVICERS.

Orlando, Florida
Sheraton Twin Towers

August 16 - 20, 1977

*
Technical workshops
for technicians.

*
Management training for
shop owners and managers.

*
Fun for the wives and kids.

*
Learn how to make
more money - FAST.

Write for convention details
to: NESDA - ISCET
1715 Expo Lane
Indianapolis, IN 46224



Fig. 9 A tower bracket was fastened to the tower using "U" bolts, and to the 2X4. Now, the tower was reasonably secure, but not perfectly vertical.



Fig. 10 Gentle taps of a sledge hammer moved the bottom of the tower to provide true vertical, as measured with a level.



Fig. 11 To prevent the tower from tipping, the base plate is firmly secured by three base stubs, which are driven into the ground.

Towers

continued from page 53

gain by increased signal strength obtained by a better antenna or a higher location produces a superior signal-to-noise ratio.

However, **the best possible SNR can be obtained only by using all three improvements: a high-gain antenna; a high location for the antenna; and, a low-noise preampli-**

fier to overcome the losses of the download.

Towers offer many advantages over roof or chimney mounts. The positive features include extra strength and rigidity, plus the cross-braces which permit a person to climb to the mast. Also, several things are eliminated, such as the possibility of roof damage, and the nuisance and undependability of guy wires. □

RCA
Chassis CTC74AA thru AF/AJ/AK/N/P/R/T 1599-2
Chassis CRK24C, CTP23A/B 1599-2-A

TRUETONE
WEG2769A-77/91A-77/91B-77/97A-77/
97B-77/99A-77 1605-2

RCA
Chassis KCS201T/U 1606-1

RCA
Chassis CTC74AH/AL 1608-1
Chassis CRK22A, DAP-1B 1608-1-A

RCA
Chassis KCS202C/R 1614-2

SEARS
564.50350500/1600 1623-2

SEARS
564.41690600, 564.41731600, 564.41900600 1624-1

JCPenney
685-2009, 2009 (855-0162) 1627-1

SONY
Chassis SCC-100A-A/F-A/G-A 1627-2

SEARS
562.41800600 1629-1

SEARS
528.44190600 1638-2

QUASAR
Chassis 9TS-482 1639-1

ZENITH
Chassis 23HC50, 23HC50Z 1639-2

ZENITH
Chassis 19HC38 1640-2

SEARS
562.40040301, 562.40041400/401,
562.40090301, 562.40091400/401 1640-3

SANYO
Chassis PD-60N00, PD-61N00, PD-70N00 1641-1

TOSHIBA
Chassis TAB-501 1642-2

SONY
Chassis SCC-100E-A/I-A 1645-2

K MART
SKC-1910, SKC-1920 1648-1

QUASAR
Chassis TS-958 1648-2



UNIVERSAL TEST RIG **DOES IT ALL**

33KV

\$229.95 **PJS-298**
C.R.T. Included

- 33KV Leaded Glass CRT
- 40KV Meter
- Build-In Speaker
- Obsolete-Proof

The PJS-298 Universal Test Rig for tube and Solid State TVs designed for servicing high voltage chassis. Built-in speaker for convenient audio checking, 40KV-50Ua sensitivity meter constant monitoring of the anode voltage. Up-dating is accomplished by means of plug-in modules. (Extension cables included).

FOR FAST TROUBLE SHOOTING . . .

"FERRET" TV MINI-ANALYZER

\$99.95
SG-785

- VHF/UHF Subber
- I.F. - Video Trouble Shooter
- Convergence Generator
- Dots and Cross-Hatch Patterns

The "FERRET" is a multi-functional instrument for fast, efficient trouble-shooting and adjustment of all Color and B&W tvs. It is ideal for both shop and field work. (Cables included.)

TeleMatic 2849 Fulton St., Brooklyn, N.Y. 11207

SERVICE ASSOCIATIONS

NESDA Convention

The 1977 National Electronic-Service Convention will be held August 16-21 at the Sheraton Towers Hotel in Orlando, Florida. This year's theme is "The Wonderful World of Service".

The convention will begin with the second annual Manufacturers/Dealers Golf Tourney on Wednesday, August 17th. The first annual "College of Service Knowledge" technical-training seminars will be conducted on the 18th, followed by the "Magic Kingdom of Electronics" Trade Show on Friday, August 19th.

Other convention activities include the NESDA Profitable Service-Management School; National Service Conference round-table discussions; and, government and industry speakers.

For more details, write to: NESDA, 1715 Expo Lane, Indianapolis, Indiana 46224.

NESDA News

The National Electronic Service Dealers Association (NESDA) has approved a certification exam and qualification program for consumer-electronics service shop owners, managers and operators.

Called the Certified Service Manager (CSM) program, the examination will test the business knowledge and management skills of service managers and operators in areas such as: customer relations, advertising and promotion, record keeping, financial understanding, demographics of the service business, personnel management, product sales, safety, and shop layout and design.

A total of four years' experience and/or schooling in service management will qualify service managers and operators to take the exam. The first CSM examinations will be administered at the National Electronic-Service Convention, to be held August 16-20 at the Sheraton Twin Towers, Orlando, Florida.

Those interested in taking the exam at the Orlando convention may register by contacting NESDA, 1715 Expo Lane, Indianapolis, Indiana 46224; phone 317/241-8160.

Subsequent testing will be conducted on a regular basis by the network of association officials and educational institutions that administer the Certified Electronics Technician (CET) program.

Professional and trade associations representing small businesses must band together if their members are to survive, California Senator David Roberti told members of the California Council of Industrial and Business Associations at their first general meeting recently.

Roberti, chairman of the Select Committee on Small Business Enterprises in the California Senate, was invited to address the group by the **California State Electronics Association** on behalf of the Council, which is less than a year old.

Roberti told the meeting that trade associations must generate support for small-business programs in

order to halt the increasing number of small-business failures recorded during the past few years.



Dick Glass (far right) presents a NESDA charter to Arlin Pennington, president of the New Mexico Electronic Service Association, at NMESA's regular board meeting held recently in Clovis, New Mexico. Glass is Executive Vice-President of NESDA.

NATESA Convention

The 28th Annual NATESA Convention will be held August 25-28, 1977 at Carson's Nordic Hills Resort in Itasca, Illinois (located between O'Hare International Airport and Chicago). The convention will begin with a golf tourney on Thursday, August 25th, and continue through Sunday, August 28th.

Convention activities will include service business management and official association business sessions, as well as a "New in Technology" seminar.

A single fee of \$25 per person covers all functions. A special block of rooms at a cost of \$33 for single and \$38 for doubles has been reserved on a first-booked basis. All meals from Friday through Sunday brunch are being sponsored by major set producer/marketers.

For additional information, write to: NATESA, 5908 South Troy Street, Chicago, Illinois 60629.

News From NATESA

The first New England regional meeting of the National Alliance of Television & Electronic Service Associations (NATESA), held February 20, was a success, despite a late-winter snow storm that hit the East Coast.

Fifty-eight persons attended the informational one-day meeting in Woburn, Massachusetts, a Boston suburb.

Gilbert P. Clark, president, ETG of Massachusetts, welcomed those in attendance.

He was followed by opening remarks from the NATESA executive council: George Weiss, president; Frank Moch, executive director; Paul Kelley, vice-president; Leo Cloutier, secretary-general; and Richard Ebare, treasurer.

The meeting also heard reports by representatives of electronic technicians associations from Maine, Vermont, New Hampshire, Massachusetts, Rhode Island and Connecticut.

CEDA Insurance

A group health-and-disability insurance program for CB retailers is being offered by the Communications Equipment Distributors Association (CEDA).

The insurance program offers CEDA Associate Dealer members the benefits of low group-insurance rates regardless of the size of the individual business. The group health insurance includes comprehensive major medical and pregnancy benefits. The disability insurance program provides benefits in addition to standard Social Security and Workmen's Compensation payments in the event of an employee's long illness or permanent disability.

Publicize Your Good Deeds

For some time, Carl Babcoke (Editor of **Electronic Servicing**) has been urging electronic technicians to publicize all of their activities that are newsworthy. These can include charitable work, community service, and other "good deeds". For several reasons, we believe you should have these things published in your local newspapers. Not only does each news item inspire others in the community to do helpful acts, it also improves the public image of technicians in general.



Gill Grieshaber and his daughter Ellen played a benefit performance at a St. Joseph, Missouri health-care center. (Photo courtesy of St. Joseph News Press)

Gill Grieshaber

Good examples of volunteer activities are the musical contributions of Gill Grieshaber and his

family. (Gill is the owner of Gill's Color TV in St. Joseph, Missouri, and a writer for **Electronic Servicing**.) He and five of the Grieshaber children are kept busy playing solos or with bands. Two of the youngsters are part-time professionals, but Gill and the others make no charge.

Recently, write-ups with pictures in both the St. Joseph News Press and the Catholic Key told about Gill and his daughter Ellen (a third-grade student) playing accordion solos and duets during the Halloween program at the Carriage-Square Health Care Center for the older residents. This is only one such contribution; these helpful deeds are regular occurrences with the Grieshaber family.

You can help, too

Perhaps you can't play a musical instrument, but everyone can do something charitable. **Electronic Servicing** has published several reports of similar activities in the past, and we urge you to have your item published locally, then send us the clippings and original photos (we can't print from published photos). We will write a condensed report to inspire other technicians and shop owners to follow the good example. □

Survival of the FITTINGEST



THORDARSON FITS

Thordarson replacements fit exactly. And they are designed and built better than the original. Thordarson gives you the industry's widest selection of replacement flame retardant flybacks and yokes. Accurate, constantly updated cross-reference data makes replacement selection fast and easy. These solid reasons, and more, are why Thordarson has survived when most others have failed.

The next time you need a flyback or yoke for any brand see your independent electronic parts distributor for a Thordarson replacement. You'll be dollars and hours ahead!

THORDARSON

THORDARSON MEISSNER, INC.
Electronic Center
Mt. Carmel, Illinois 62863

Support your independent parts distributor . . . we do! NEDA Associate Member

Sequel To "The Trouble With Troubleshooting"

By Carl Babcoke

*In the February, 1977 issue of ELECTRONIC SERVICING, an article by Thomas J. Schum suggested that schematics show a **range** of DC and peak-to-peak voltages, rather than a nominal voltage. We asked for your comments and suggestions for "Joe Trainee", and many wrote to us. In this article we are presenting some condensed excerpts from those letters, plus a summary.*

The consensus from many readers of the "Trouble With Troubleshooting" article is that **all** beginners (and some of us old-timers!) have problems with voltages which do not conform to those on a schematic. However, many different suggestions were made about the best solution. First, here are some condensed comments from these letters.

Yes, We Want Voltage Tolerances

A range of voltages listed on schematics would be helpful, but a tolerance expressed in percentage would be better, wrote David Bloomer of Rochester, New York.

"I can identify very well with Joe Trainee," stated Theodore Laux of Baltimore, Maryland. Although he scored a high 96% on the CET test, he admits to doubt when a voltage differs from the schematic (as it often does), and has wasted time troubleshooting a non-defective circuit. He went on to say he gladly would pay extra (perhaps 50 cents per Photofact) for additional information, including either a percentage or a range of voltages.

Harry Samuels, a group leader with E. F. Johnson technical publications, said the Johnson schematics now include **average** voltage readings taken from a sampling of 10 CB radios. However, he added that recent comments from field-

service technicians indicate a need for high and low limits, and this possibility is being studied.

The entire 12-member electronics class of Lees Junior College in Jackson, Kentucky agreed with the need for minimum and maximum voltages.

"Let's have better servicing information, including voltage **ranges**, test points, waveshapes, and everything else that will help us," wrote H. C. Minton, Jr., who lives in Aiken, South Carolina.

J. D. Speicher of Bellerose, New York suggests listing more voltages and other data than would appear necessary. Then, let the technician decide which he needs.

An interesting thought was expressed by Ralph Manginello of Ft. Lauderdale, Florida. He agreed with the need for a range of voltages, but then added a question. If a range of +11.2/+15.4 were listed, would this area of "correct" voltages be considered absolute? What of voltages just slightly higher or lower?

"I believe if the voltages were listed as a range, rather than a single value, that it would speed up troubleshooting and repair time," commented M. L. Whitt, who lives in Springville, Tennessee.

Ernest Cook, a service manager in Shreveport, Louisiana wrote, "Joe is **not** asking the wrong ques-

tion...the solid-state devices make a digital voltmeter necessary."

John Racz (Hoffman Estates, Illinois) agreed with the need for highest and lowest normal voltages, and advocated a way of identifying the voltages where little variance is permissible. Also, he wrote that using a variac, isolation transformer, and line-voltage meter to adjust for an accurate 120 volts produced voltages much nearer those on schematics.

Mike Buttner, whose address apparently was thrown out with the envelope, agreed that slight differences of voltage or waveform promoted confusion and wasted time. He attended a Zenith one-day school and was surprised to learn of some solid-state voltages that could differ by several volts, and of others which must be accurate to about 0.1 volt.

In addition to voltage ranges or percentages, Harry Gebhart of Cadyville, New York wants the RF voltages specified in decibels, and suggests more waveforms on schematics.

Even a nominal voltage with a percentage would be a great help, said T. W. Jefferson of Milton, West Virginia. This would indirectly be to the advantage of the manufacturer who made such schematic improvements, because more technicians would recommend his brand.

"I have never found a TV yet that all voltages measured were normal," stated Alfred Petersen (Auburn, Maine). Meter loading might be a factor, in addition to the accuracy of individual meters. However, he favors something to show how critical the readings are.

Perhaps It Would Help

A few readers gave partial agreement. For example, Dave Wright of Kingston, Tennessee thought the normal voltage ranges would help some, but insisted that the inclusion of voltages and waveforms at more points would be better.

Marvin Hoffman of Concordia, Kansas advises his young technician helper not to spend an excessive amount of time on a problem before searching for another schematic to give a **comparison** of voltages and parts values.

No, Voltage Ranges Are Not Needed

Although he has gone through a "Joe Trainee" period himself, Bob Dose of Wabasha, Minnesota be-

lieves we shouldn't blame the service data for not telling us everything. Acutally, each schematic gives us enough information, if we are experienced or well-trained enough to know whether a wrong voltage is not important, is the **result** of a problem, or is the **problem** itself. He goes on to advise each technician to specialize in just one brand. Otherwise there is not enough time to understand them thoroughly.

Use the "black box" approach, advises Glen Bryant of Hoisington, Kansas, to identify the defective stage. When the output signal is okay, the voltages of the stage are not very important. "I do not see much sense in making schematic voltages take on the characteristics of the average weather report."

"I do not see the listing of voltage ranges as beneficial," stated Ron Combs, a service manager in Fort Worth, Texas. Tube-type sets make up about 60% of his bench work, and the voltages are not that critical. In addition, voltage ranges might help beginning techs slightly,

but it would take away from the ones now working efficiently with exact voltages.

It takes a lot more than textbook theory to repair a TV set properly. A trainee needs more than "try this, replace that". Instead he must understand **why** he should suspect a certain stage: he needs to grasp the concept of systematic troubleshooting techniques. These are some thoughts from Don Hopkins of Salt Lake City, Utah.

"I have used a Simpson digital voltmeter for the last few years, and can measure down to one millivolt, but it doesn't prove anything over my FET voltmeter, except in dealing with critical transistor biases," wrote Monty Huckle of Tahoe City, California. Only an **analysis** of the circuits will enable "Joe" to know whether or not a wrong voltage is important.

William Blankinship, whose shop is in Rusk, Texas, was sympathetic with "Joe Trainee" and advises him to keep trying, for understanding will come with time and experience.

continued on page 60

Three ways you can put test bench performance in your pocket with Hickok.

SPECIAL LIMITED TIME OFFER

Your choice **\$99⁰⁰** At participating Hickok distributors



Model 215
A fully automatic in-circuit semiconductor analyzer.
\$138

Model 239
A rock-solid MOS LSI color bar generator.
\$129

Model 350
A true auto polarity 10 megohm FET multimeter.
\$135

Now you can take the equipment you need wherever you need it with these versatile pocket performers from Hickok.

Our Model 215 Pocket semiconductor analyzer checks transistors, FETs, diodes and SCRs for conductance and gross leakage and identifies base or gate leads both in and out of circuit. And it does it all with a self-sequencing good/bad test and LED display.

Hickok-developed MOS LSI ICs give our Model 239 Pocket Color Bar Generator exceptional reliability, extremely low battery drain, rugged industrial performance and crystal stability. Simple matrix switches select any of its nine patterns, including a gated rainbow. And you can put its output on channels 2, 3 or 4.

The Model 350 Pocket FET multimeter features foolproof overload protection, true auto polarity, a polarity indicator and 10 megohm input impedance. It measures 9 dc voltage ranges, 9 ac voltage ranges, 7 hi/low resistance ranges and decibels. And it displays its findings on a long 2.4" mirrored arc.

But don't just take our word for the way these midget marvels perform. Ask your Hickok distributor for a demonstration. He may even offer a 10 day trial. Then we've got you for sure.

HICKOK

the value innovator
INSTRUMENTATION & CONTROLS DIVISION
THE HICKOK ELECTRICAL INSTRUMENT CO.
10514 Oupont Avenue • Cleveland, Ohio 44108
(216) 541-8060 • TWX: 810-421-8286

For More Details Circle (16) on Reply Card

Trouble

continued from page 59

But he believes that specific voltages are not practical, because of the types of problems, age of the receiver, and whether the set had been worked on before.

"Joe is asking the wrong question," wrote Bob Greene of Topsfield, Massachusetts. Joe should go back to school, where the teachers are experienced in actual field repairs, and learn how to diagnose. Tell Joe not to clamp his mind on a hurried diagnosis just because one voltage is wrong. A **series** of measurements should be made in all circuits that could affect the problem. An approximate voltage listing is okay for 99% of all TV defects.

Thanks

Our sincere "Thanks" go to the men whose comments were listed previously, and also to R. A. Lopez (who was strongly opposed to "shot-gunning"), C. E. Leukering, Carl Keltz, Dave Wright, R. L. Williams, Al Kavaky, and W. P. Pero. Many of the letters were very detailed, and could not be summarized adequately in a few sentences.

Editorial Comments

Even before I became an editor of **Electronic Servicing**, I was involved deeply with technical training. As a district service manager for a major manufacturer for 14 years, I put on countless one-evening seminars, in addition to teaching many formal night-school courses. One of my satisfactions has been the careers of my students and proteges. Some have become national or area service managers, for example.

Therefore, I have spent much time thinking about possible solutions for many general electronic problems, such as the one described by "Joe Trainee". **None of the problems have simple solutions.** When time permits, we hope to feature articles dealing solely with all facets of troubleshooting.

Troubleshooting divides naturally into about three basic branches: (1) sensory tests (sight, touch, feeling, hearing, and physical manipulation); (2) past history (your remembrance of past defects, plus files of other techs' experiences; and (3) methodical tests with adequate

equipment, which eventually can locate **any** problem.

Sometimes a subscriber will write to us, "This set is not bright enough. Which part do I replace?" Of course, many parts failures are repetitive (that's why we publish Symcures), and knowing the likelihood of a failure can save much time. But, no one (including myself) can possibly know about **all** such failures; voltage analysis is needed in this case. I'm sorry for any techs who stop with basics 1 and 2, without trying number 3.

Now, the number 3 basic has its own share of pitfalls, especially when you first begin seriously to practice it. This is "Joe's" primary problem. **He knows he must analyze methodically, but becomes confused by the readings his test equipment gives him.** We "old timers" are not immune to such miseries, either; but the bad cases become more rare with practice.

Let me give some practical examples showing why some voltages **must** be different from those shown on a schematic.

Voltage change with signal strength

In typical color TV's, the DC voltages in the RF stage, first IF (and sometimes the second IF, too), video detector, all video stages, and either the grids or cathodes of the picture tube all change with different levels of signal strength. Naturally, the voltages of the AGC tubes or transistors change even more. Of the signal circuits only the tuner mixer and the last IF are not supposed to have varying voltages.

Manufacturers can't know what signal strength you will encounter, so many show only the DC voltages that are typical with the antenna leads removed, a short jumper across the antenna terminals, and the tuner set for an unused channel.

Except for snow and perhaps vertical and horizontal blanking in the video amplifiers, this lack of an input signal would make any waveforms useless. So, the schematics show the video and chroma waveforms as they are **with** a normal station or color bar signal.

This often produces the peculiar condition of the DC voltages indicating a color killer that's eliminating the color gain, but the waveforms show full color! Wait until "Joe Trainee" runs head on into

this situation!

Even though no standard voltages for a strong signal can be given; some ballpark figure is much better than none. So, I recommend listing both "no signal" and "strong signal" DC voltage for **any** that change with level.

Voltages change with adjustments

Most color receivers change brightness settings by varying a video DC voltage, and the downstream direct-coupled video stages pass along the change until it becomes a bias change at the picture tube. Also, all CRT screen grids are adjustable, and most control-grid bias or video level is varied during gray-scale tracking. Therefore, none of these voltages can have absolute values.

The same general comments apply to video peak-to-peak readings; they depend on the AGC settings and on the contrast adjustment.

Suggestions For Schematics

Many more examples could be given, but those should be enough for now.

These suggestions for better schematics I offer free of charge:

- Any DC voltages that change from an adjustment should have a symbol (perhaps an asterisk) placed before the polarity and voltage;
- Any DC voltages that change according to the incoming signal level should be preceded by a symbol (perhaps a star), and both no-signal and strong-signal voltages should be shown;
- DC voltages should be shown at both anode and cathode of diodes, or any varistors used for a diode function (did you ever need to know the voltage from a bias rectifier, a blanking diode, or a varistor in a HV regulator circuit?);
- Color killer should have DC voltages shown for both conditions;
- Another symbol (square?) should precede any DC voltage readings that are very **critical**; and
- More waveforms should be shown, especially around power supplies operated from horizontal sweep, rather than from 60-Hz sine waves.

These are some changes that are vitally needed to speed-up the servicing of electronic equipment. **The coming digital revolution demands higher competence from all technicians.** □

CARTOON CORNER



"All this isn't going to do you a lick of good, Mrs. Pherson!"



"Do not adjust your set, folks. We're having transmission difficulties!"

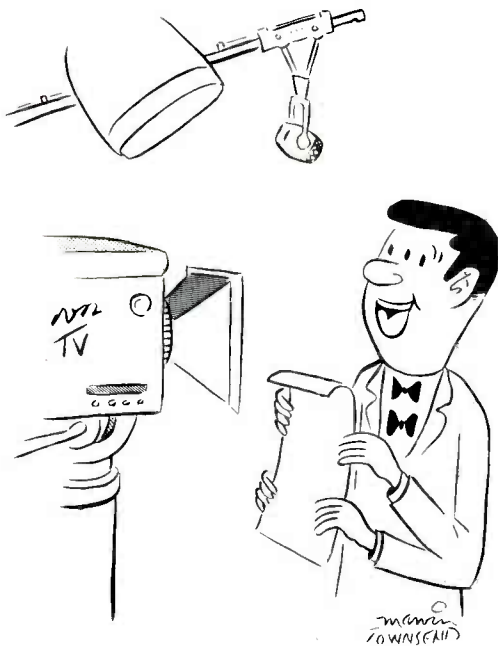

"This telecast is brought to you by your local TV-Service Shop."



"...Then, check Q2 in the AGC system!"

TRANS-VISTA ELECTRONICS

Distributors Of Transistors And Famous Trans-Vista Electron Tubes

80% To 90% OFF
LIST PRICES OF TUBES BELOW

Type	List Price	Your Cost	Type	List Price	Your Cost
1G3	5.25	.78	6GH8A	4.20	.73
3A3	5.35	.91	6HA5	5.10	.88
3AT2	5.20	.83	6HZ6	4.25	.71
3DB3	5.85	.93	6JE6	11.15	1.67
3GK5	5.15	.87	6JS6	9.90	1.38
5GS7	3.70	.67	6KD6	11.25	1.49
6AD10	12.25	1.59	6LF6	10.65	1.62
6AW8A	5.95	.84	6LX8	3.50	.52
6BA11	6.50	.85	8FQ7	4.05	.69
6BK4	9.95	1.41	12BY7	4.75	.61
6BZ6	6.95	.70	17AY3	5.05	.75
6CG3	5.25	.81	17JZ8	4.75	.71
6CJ3	5.05	.79	19CG3	6.65	.99
6EJ7	4.75	.76	22KM6	10.25	1.39
6FQ7	4.05	.69	33GY7	8.05	1.20
6GF7A	7.05	.99	38HE7	9.75	.99

Trans-Vista sells all types of tubes at 80% off list prices. To figure your cost multiply current list price by 20. Order today!

TRANSISTOR SPECIALS

Our No.	Similar To	List Price	Your Cost	Our No.	Similar To	List Price	Your Cost
TVE5	ECG123A	2.20	.79	TVE8	SK3019	2.55	.84
TVE7	ECG128	3.30	.91	TVE9	ECG152	4.20	1.09
TVE3	SK3004	1.90	.72	TVE12	ECG165	19.50	4.87

1 million transistors in stock. Order any type not listed at 75% off list prices.

Terms: All shipping charges paid on pre-paid orders. Send full remittance, un-used money returned. COD orders 25% deposit.

PHONE ORDERS CALL (201) 688-1466

All tubes individually boxed, branded, lab tested new, 2nds., or used. 1 year warranty. Money back if not satisfied. Use this ad as order form. Send for free tube and transistor lists.

TRANS-VISTA

795 Colonial Arms Road
Union, N.J. 07083(DEPT. ES-5)

For More Details Circle (20) on Reply Card

SERIOUS ABOUT YOUR FUTURE IN HOME ELECTRONIC SERVICE?



The Sign of Professional Service

...a not for profit association championing independents' right to compete, and delivering valuable benefits continuously since 1950.

NATESA offers low cost group insurance, discounts on everything from eyeglasses to motor vehicles, individual consultation on particular problems, representation to government and industry at all levels and a place to unite to protect each individual member with the strength of all.

Send this ad with your card or letterhead to:

NATESA, Dept. ES
5908 S. Troy St.
Chicago, Il. 60629

- Membership. \$60.00 enclosed. As our member premium, please send free . . .
- Practical Business Manual - OR -
- Service Contract Manual

productreport

These features supplied by the manufacturers are listed at no-charge to them as a service to our readers. If you want factory bulletins, circle the corresponding number on the Reply Card and mail it to us.

Digital Telephone Dialer

A new automatic alarm dialer by Mountain West protects property from burglary, fire, or illegal intrusion by sending a silent, pre-coded message over regular telephone lines.

The alarm dialer is connected to burglar-alarm system controls, fire-detectors, or other types of detectors, and then to a telephone system. Phone numbers up to 8 digits can be set quickly into the dialer, and tone codes from 1 to 110 may be pro-

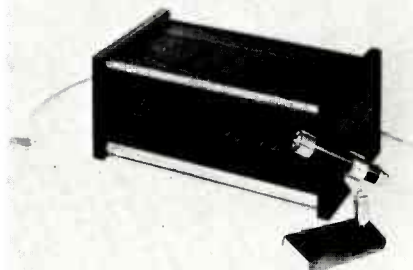

grammed on the coder. When activated by alarm signal, the D8 Dialer will "dial" the programmed phone number and transmit an audible tone code. (If number is busy, dialer will reset and redial until phone is answered.) Then the line stays open for about 1½ minutes so the listener can confirm an intrusion by hearing noises in the protected area.

The D8 uses solid-state digital and audio circuits, and has a self-contained battery power supply.

For More Details Circle (29) on Reply Card

8-Track Tape Cleaner

The "Soundtrack Scrubber" from Robins Industries cleans and polishes tape while it's inside the 8-track cartridge. The cartridge to be cleaned is plugged into the "Soundtrack Scrubber," and in turn, it is inserted into the tape machine, in the usual way. As the machine runs, a capstan in the cleaner moves the cartridge tape against the mildly-abrasive polyester cleaning tape. All tracks are cleaned at the same time, so a 60-minute tape can be cleaned in only 15 minutes of operation.

After the tape in each cartridge is cleaned, the cleaning tape should be

advanced slightly to expose a fresh surface for the next cartridge. Each "Sound Scrubber" comes with enough cleaning tape to clean about 200 tape cartridges, and a new reel can be installed when needed.

For More Details Circle (30) on Reply Card

Electronic Tools

Xcelite's diverse line of hand tools for electronic product assembly, maintenance, and service includes fixed-handle screwdrivers and nutdrivers; pliers and cutters with Cushion-Grip



handles; the Series "99" interchangeable screwdriver/nutdriver blades and handles in sets, kits, and individual components; shears; snips; adjustable wrenches; and wire strippers.

For More Details Circle (31) on Reply Card

CB Transceiver

Pearce-Simpson's "Lion" 40-channel mobile CB transceiver is a full-feature set with LED channel readout, "Hetrolock" circuitry for precision performance, and three-position "Receiv-O-Slide", for varying the receive frequency about 1 KHz.

The receiver features high sensitivity, a low-noise RF stage, automatic noise limiter, noise blanker, ceramic filter, external speaker, and PA jacks.



An integral SWR/CAL/RS/S meter gives relative strength of incoming signals regardless of SWR/CAL/RF switch setting. It also measures transmitter power when in the RF position.

For More Details Circle (32) on Reply Card

Degreaser/Solvent

Chemtronics is introducing a new line of aerosol chemicals for industrial electronic use.

The first of these new items is an electronic degreaser and solvent (Number C-2480) which is 97% Dupont Freon TF. This aerosol cleaner dissolves and flushes away oil, grease, dust, corrosion, and most other contaminants. It evaporates rapidly, leaving no residue. C-2480 will not harm any components, circuit boards, plas-



tics, metals, elastomers, paint, or varnish, and is non-flammable.

Freon TF is available in one- and five-gallon cans, as well as a 24-ounce aerosol.

For More Details Circle (33) on Reply Card

New

DIGITAL COLOR CONVERGENCE GENERATOR
 Uses latest CMOS-LSI technology. For servicing Color TV, etc. Selects up to 16 patterns. As low as \$39.95 (kit). Plans Kit or Wired \$5.00. RF & Video output. 2 Yr. Warranty.
 SEND FOR DATA NOW...Dept. ES1
SCIENCE WORKSHOP BOX 393 BETHPAGE, N.Y. 11714

For More Details Circle (34) on Reply Card

FREE ALARM CATALOG
 Huge selection of burglar & fire systems, supplies. Motion detectors, infrared beams, controls, door switches, bells, sirens. 900 items, 64 pp. packed with technical details, notes.
 Phone (602) 263-8831

mountain west alarm
 4215 n. 16th st., phoenix, az. 85016

For More Details Circle (27) on Reply Card

IT'S NO PUZZLE
 TO ORDER

OELRICH SERVICE FORMS
 FOR TV-RADIO & 2 WAY RADIO SERVICE LEGAL FORMS FOR CALIF. FLA. UTAH NOW AT YOUR PARTS JOBBER OR WRITE FOR CATALOG B64
OELRICH PUBLICATIONS
 4040 N. NASHVILLE AVE. CHICAGO, ILLINOIS 60634

For More Details Circle (28) on Reply Card

SUBBER®

MARK IV-CUVB

A TIMESAVING INSTRUMENT BY CASTLE



UHF-VHF TV tuner and i-f signal analyst
 Incorporates these important features:

- Tunes all UHF & VHF Channels
- Electronic Fine Tuning
- Dual 40 MHZ IF Output Jacks
- Battery Condition Indicator

MARK IV-CUVB
 (BATTERY POWERED ONLY)

Net \$64.95



CASTLE ELECTRONICS

5233 Old South Highway 37 Bloomington, Indiana 47401

For More Details and Specifications Contact Your Nearest Distributor
 In Canada: Len Finkler Ltd; Ontario

For More Details Circle (18) on Reply Card

MAKE YOUR MARK



...and save money, too,
 on a four-pack of Perma Power
 Color-Brite Briteners. Model C-511

This tungsten carbide marking tool writes on anything—metal, glass, plastic, or ceramic—to instantly provide engraved identification of valuables—yours and your customers'. It's free with Perma Power Color-Brite, and with Color-Brite, you'll be proud to sign your work! The fast and simple installation immediately restores sharpness, contrast and faded color to worn color picture tubes. It restores your customer's smile, too, because you've put off replacement of the

expensive color picture tube. And when replacement time does come around, that smiling customer will remember that you saved her money... so you'll get the profit on the sale of a new CRT!

So don't forget Model C-511 Color Brites, the ones you use most. Buy now, and get the free marking tool, while you save more than a dollar a britener, too!

Hurry to your distributor today! Offer valid while marking tool supply lasts.

Perma Power Color-Brite

A PRODUCT OF  Chamberlain

Chamberlain Manufacturing Corporation
 Perma Power Division
 5740 N. Tripp Avenue • Chicago, Illinois 60646
 Telephone (312) 539-7171

For More Details Circle (19) on Reply Card

test equipment report

These features supplied by the manufacturers are listed at no-charge to them as a service to our readers. If you want factory bulletins, circle the corresponding number on the Reply Card and mail it to us.

Digital Multimeter

Model LM-40, the 4-digit multimeter from **Non-Linear Systems**, gives 10,000 counts full scale compared to only 2000 counts FS for a 3½-digit multimeter. AC and DC voltage ranges of 1, 10, 100, and 1000 full scale have resolution down to 100 microvolts, and an input of 10 megohms. Automatic polarity is provided for DC voltages, and the basic accuracy is 0.1%.



Ohmmeter ranges of 1K, 10K, 1000K, and 10 megohms have a resolution of 100 milliohms, with fuseless protection (said to be an exclusive feature of NLS multimeters).

External current shunts providing ranges of 0.1, 1, 10, 100, 1000, and 2000 milliamperes are optionally available for AC and DC current measurements.

Automatic zeroing is a feature of all functions and ranges. The LM-40 comes with test leads, internal Ni-Cad batteries, and an external charger unit. Technicians price is \$190.

For More Details Circle (35) on Reply Card

Portable Frequency Counter

B&K-Precision, Dynascan Corporation, has introduced a portable frequency counter with full six-digit display and guaranteed operation to 30 MHz with 1 Hz resolution.

The Model 1827 frequency counter features 1-parts-per-million resolution on a six-digit scale with ± 0.25 -PPM stability. The input circuitry is sensitive enough to display a 100 mV sinewave signal, but is protected against an input signal of up to 200 volts (peak AC & DC).

An optional signal tap allows the 1827 continually to monitor the output of a 23- or 40-channel CB transceiver without affecting normal set operation. The signal tap is rated at 100 watts.



Other optional accessories include rechargeable batteries and an AC adapter/charger, an under-shelf or under-dash mounting bracket, 27 MHz pickup antenna (for use near portable transceivers), general-purpose input clip-lead, and vinyl carrying case.

For More Details Circle (36) on Reply Card

Color Generator

Eico announces the small new Model 388 color-bar/pattern generator for the test or adjustment of color and B&W television receivers.

In addition to the 10 standard gated-rainbow color bars, Model 388 provides 8 different combinations of dots, vertical bars, and horizontal bars for all centering and convergence adjustments.

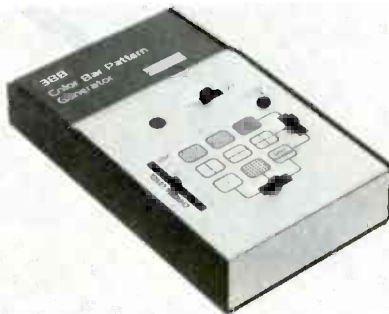

A crystal-controlled oscillator and digital count-down circuits give stability. An LED shows when the unit is on, and Model 388 can be operated from two standard 9-volt batteries, or from rechargeable Ni-Cad cells. Price is \$99.95.

For More Details Circle (37) on Reply Card

Audio Spectrum Analyzer

ADI has announced the availability of their precision audio spectrum analyzer system. Among the applications are: speaker-response measurements; room testing; equalization; A-B comparisons; and microphone and recorder evaluation.

New features are two separate memories for "freezing frame" displays; precision noise generator with gating; calibrated condenser microphone, microphone and line inputs, and scope outputs.

The unit uses ANSI-acceptable octave band filters covering 20 Hz to 22 KHz, FET multiplexers, CMOS ICs, and RAMs.

For More Details Circle (38) on Reply Card

RF Absorption Wattmeter

Model 6104 "Termaline" RF absorption wattmeter from **Bird Electronics** is a four-range unit offered at a two-range price. The four ranges are 2W, 6W, 20W and 60W, with an accuracy of $\pm 5\%$ of full scale. The



frequency range has been extended to cover 25 to 512 MHz. This adds CB servicing at the low end and land-mobile maintenance at the high end. Load VSWR is 1.1 from DC to 512 MHz and the meter case can be detached for convenient readout. Single unit price is \$249.

For More Details Circle (39) on Reply Card

Digital Multimeter

The Model 3435A, 3½ digital auto-ranging multimeter from **Hewlett-Packard** comes with a "touch hold" probe accessory, a convenience when probing closely-packed circuit boards.

Voltages are measured from 200 microvolts to 1200 volts DC, while AC measurements range from 200 microvolts to 1200 volts RMS. Resistance is measured from 10 milliohms to 20 megohms. AC and DC current can be measured from 200 microamps to 2 amperes.

Model 3435A will take either internal AC power supply or rechargeable lead-acid batteries. Price of the multimeter is \$400; the "touch-hold" probe is \$40.

For More Details Circle (40) on Reply Card

antenna systems report

These features supplied by the manufacturers are listed at no-charge to them as a service to our readers. If you want factory bulletins, circle the corresponding number on the Reply Card and mail it to us.

CB Antenna System

Designed for trucks, motor homes and other recreational vehicles, the **Avanti AV-529** CB antenna system is said to increase performance approximately 25% over single roof-mounted antennas and minimizes the problem of a skewed or shifted radiation pattern.

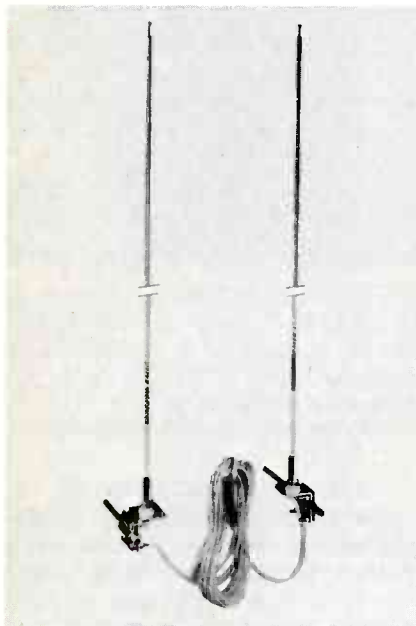

The system consists of two 4-foot fiberglass antennas, in a co-phased arrangement, mounted on the outside rear-view mirrors.

The mounting assembly fits most mirror-bracket arrangements.

For More Details Circle (41) on Reply Card

Antenna Tuner

A new base-station or multi-antenna tuner by **Norcom Electronics** provides in-line operation while isolating the coax lead-in from ground-loop radiation, which can weaken signal transmission or damage the transceiver.

Working with an electrical field system, the "Back Talk Antenna Tuner" permits the use of any practical coax length, regardless of antenna type. The tuner tunes the antenna, not the coax. Thus, coax

signal radiation is minimized.

Recommended for multi-antenna installations, trucks, mobile homes, base stations, the **Back Talk Antenna Tuner** requires little space, measuring only 2 1/4" x 4-3/8" x 3 1/4". Unit weight is 12 ounces.

The tuner comes complete with two PL-258, one 9-inch coax, and one PL-259 connector. Suggested retail price is \$49.95.

For More Details Circle (42) on Reply Card

Base Station CB Antenna

Channel Master has introduced the "Golden Hawk", an omni-directional base-station CB antenna that can be assembled rapidly.



Model 5050 has preassembled construction, and is opened like an umbrella. There are no loose parts, except for three screw-in capacitive loading stubs. Made of aircraft-alloy aluminum, it weighs only four pounds.

The 16-foot antenna is a 1/2-wave dipole with 1.3:1 SWR or better across the entire 40-channel CB band. It has an average gain of 5 dB.

For More Details Circle (43) on Reply Card

CB Antenna Maintenance Products

GC Electronics has introduced two CB antenna care products. The **Tennacap (18-1080)**, an aluminum cap for all standard base-loaded antennas, fits over and protects the base threads when the antenna is removed. It also can be used to protect the antenna connector threads of transceivers.

Tennalube (18-927) is formulated of type Z5 silicone compound, and can be used for weatherproofing antenna threads, thus allowing easier removal of CB antennas. Use of **Tennalube** will keep threads from rusting, and help prevent corrosion.

For More Details Circle (44) on Reply Card

Don't cut yourself out of a career as a two-way radio technician...

MTI offers the only training for professional FM two-way radio available. Qualified technicians are employed in government, industry, and public service. But training is your key.

You could cut out a career as a two-way radio technician by cutting out this coupon. We'll send you information on how you can learn more about this specialized field, at home.

Name _____

Address _____

City/State/Zip _____

I am a veteran or serviceman on active duty. EEB



formerly

MOTOROLA TRAINING INSTITUTE

College Hill, Summerdale, Pennsylvania 17093

For More Details Circle (21) on Reply Card

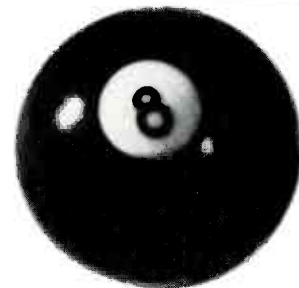

8-TRACK REPAIRS?

Want to get out from behind the 8-Ball? Then pocket your 8-Track repair problems with an FRM Kit from Projector-Recorder Belt Corporation. A revolutionary repair concept! Each kit contains 25 endless flat rubber belts, sizes 6.1" to 16.8" I.C. These precision belts fit virtually all 8-Track players. Each kit contains our handy Belt Sizer. You select the belt you need without cross reference or catalogs. For a limited time, the FRM Kits have been reduced to \$34.18, a 10-percent saving to you. Order your FRM Kit today; it's a repairman's must.

Dealer Inquiries Invited

PROJECTOR-RECORDER BELT CORPORATION

301 Whitewater St., Whitewater, WI 53190
(414) 473-2151

24-Hour Answering Service
For More Details Circle (22) on Reply Card

Repair Microwave Ovens For Profit!

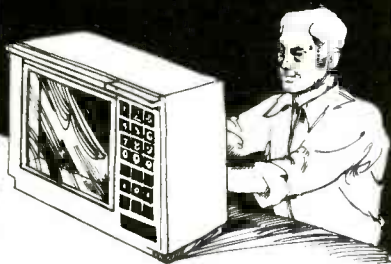

Microwave ovens are the wave of the future. Millions are in use today in homes, restaurants, institutions. By 1987 every home will have one. Who will service these microwave ovens in your area? YOU CAN! If you are in a community under one million, and looking for a part or full-time income opportunity, subscribe to Micro-Ovens Technical Services — the nation's largest microwave oven repair organization. We offer you assistance with parts, technical assistance and service call leads. Check the reply card number below and mail today!

MICRO-OVENS TECHNICAL SERVICES

3383 E. Layton Avenue
Cudahy, Wisconsin 53110

For More Details Circle (23) on Reply Card

Solution to: WIRE YOU WAITING?

- | | |
|----------------|-----------------|
| 1. attenuation | 14. porcelain |
| 2. statfarad | 15. molecular |
| 3. fatigue | 16. construct |
| 4. stability | 17. parasitic |
| 5. contactor | 18. composite |
| 6. Estiatron | 19. flammable |
| 7. facsimile | 20. ultrahigh |
| 8. reactance | 21. stripping |
| 9. permeance | 22. backplate |
| 10. quiescent | 23. compensator |
| 11. direction | 24. defective |
| 12. arbitrary | 25. white |
| 13. dichroism | |

Start with 100 points and deduct 4 points for any part you may not have answered correctly.

Your rating:

- | | |
|-------|---|
| 60-64 | Not bad but not good. |
| 68-72 | Good but not excellent. |
| 76-84 | Excellent but not sensational. |
| 88-96 | Sensational but not perfect. |
| 100 | PERFECT! You win this month's imaginary trophy! |

audio systems report

These features supplied by the manufacturers are listed at no-charge to them as a service to our readers. If you want factory bulletins, circle the corresponding number on the Reply Card and mail it to us.

Tape Without Blank Leaders

The inconvenience of losing valuable recorded material because of blank leaders on audio cassettes is now said to be prevented by the new "IRC" line of cassettes from 3M Company. The "instant recording" cassettes have leaders of low-noise recording tape, making recording possible as soon as tape motion begins.



In the "IRC" line, leaders are of heavy-duty (1.5-mil) tape, while "body" tapes are thinner to accommodate long recording times.

For More Details Circle (45) on Reply Card

8-Track Tape Player

Model S200, an 8-track stereo-matrix player with FM/MPX radio has been introduced by Craig. The unit features AFC, and a local-distant pushbutton to prevent overload with



strong signals. When four speakers are used, the S200's matrix circuitry synthesizes sound quadraphonically from either FM-stereo broadcasts or the tape player. The unit's compact

size allows it to fit under the dash of most automobiles.

For More Details Circle (46) on Reply Card

Speaker System

The Realistic Optimus T-100 tower speaker system from Radio Shack features two 8-inch acoustic-suspension woofers and a wide-range 3-inch tweeter. A 3-way control permits

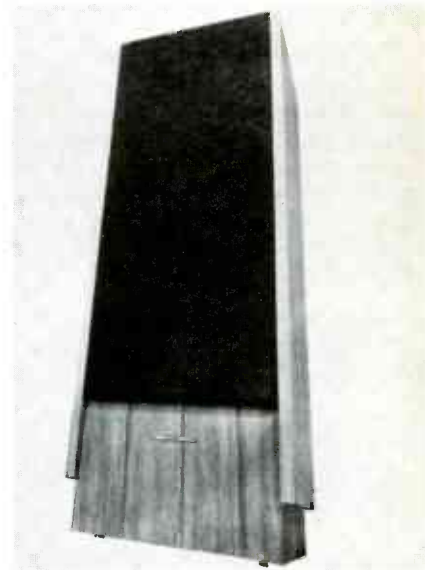

adjustment of the treble response to suit the room acoustics. The system has an impedance of 8 ohms and a response rating of 55-18,000 Hz \pm 3 dB with a crossover at 3500 Hz.

For More Details Circle (47) on Reply Card

AM-FM/Stereo Receiver

The R336 AM-FM/stereo receiver by Scott has clutched bass and treble controls for altering the frequency response of one channel without affecting the other. The unit supplies 42 watts per channel with both channels driven into 8 ohms, from 20 Hz to 20 KHz with no more than 0.3

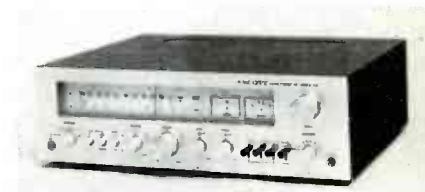

percent total harmonic distortion. IM distortion is lower than 0.15 percent. The R336 also features two independent tape monitors, meters for signal strength and center tuning, and a three-position FM de-emphasis switch. The power output stage is built around hermetically-sealed TO-3 output transistors. The R336 sells for less than \$400.

For More Details Circle (48) on Reply Card

catalogs literature

Circle appropriate number on Reader Service Card.

85. TRW/IRC—has a 28-page illustrated booklet of comprehensive technical specifications for more than 20 resistor configurations ranging from 1/20-watt, 0.01%-tolerance non-inductive thin-film resistors to 250-watt, high-power wire-wounds. Featured are high-voltage thick-film dividers for CRT, power supply, electrostatic copier and other 10-KV to 30-KV applications.

86. University Sound—presents a 16-page catalog featuring product information on explosion-proof drivers, column speakers, horns, multi-duty speakers, underwater and weatherproof speakers, and paging-talkback speakers. A section is devoted to technical aids, including a guide to basic sound-system design.

87. Winegard Industries—has released its first catalog designed to acquaint the CB dealer and consumer with Winegard 40-channel mobile CB antennas, while providing technical information. "Catalog 770" pictures base-load, center-load, and top-load models, and lists various specifications. Also included is a listing of antenna replacement parts and accessories, such as coaxial cables, mounts, whips, connectors, and coils with springs.

88. Accrediting Commission, NATTS—has issued the annual directory of accredited vocational schools which lists 430 schools, with 132 specializing in electronics. The 100-page directory is useful for locating training facilities and qualified graduates.

89. Triad-Utrad—presents a 12-page, short-form catalog covering power transformers for power-supply, control and filament circuits, and for low-voltage, low-current plug-in printed circuit power transformers.

90. Argos—has released 12-page 3-color catalogs with photos and

specs of its sound systems and components, including sound columns, portable sound systems, baffle/speakers, wall baffles and CB base and mobile speakers. Specifications include weights and measures in the standard and metric systems. The products are described according to their acoustical application to specific market areas.

92. Waldom Electronics—has a new six-page booklet describing life-saving rules for the entire family to follow in the event of a fire. The booklet stresses the importance of early fire detection via modern electronic warning devices. It also offers a basic escape plan that can be practiced by the family to minimize panic and expedite escape from any dwelling.

93. O.K. Machine and Tool—has released the latest edition of "Catalog 36G" with many new additions to the O.K. line of wire-wrapping tools, machines, and associated products. The 58-page catalog covers the technology of wire-wrapping, circuit boards, closures, and instrument cases.

96. Cerro Communication Products—has a four-page brochure covering a new line of 50-ohm and 75-ohm cable for CB, land mobile, and marine radio applications, and includes physical and electrical properties in a comprehensive chart. "Catalog 9876" also discusses 8, 58, 59, and 174/U type cable, which are available in various bulk lengths.

98. Jensen Tools and Alloys—has a 128-page catalog of unusual and hard-to-find tools. Over 2800 tools are categorized under micro-tools, power tools, test equipment, soldering equipment, engineering supplies, screwdrivers, pliers, wire strippers, and tweezers in addition to a 30-page section featuring Jensen tool kits and tool cases. The catalog also covers technical data on tool selection, metric and temperature-conversion charts, glossaries of tool terms, equivalency tables, safety tips, and specific information on plastics and the solderability, tensile strength, and melting point of various metals.

C. T. CURTIS CB TEST STATION

Model 105

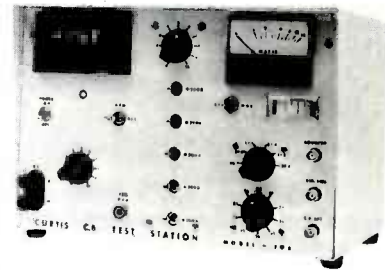

DEALERS - SERVICEMEN
A CB Tester Complete in Itself

- Easy, fast test of all CB's
- 3A. Adjustable/Regulated Power Supply
- 60 channel calibrated signal generator. XTAL synthesized.
- 12 Watt Dummy Load.
- 0-10 Watt peak R.F. power meter.
- 3½ digit DVM .01-19.99 Volt
- Small-compact 8"x12"x8"

List price \$725.00
Distributors' inquiries invited.

Charles T. Curtis

Consulting Electronic Engineer
2558 Park Rd.
Warrington, Pa. 18976

For More Details Circle (24) on Reply Card



CET — MD

Just a few letters
Spell the difference
That is professionalism

If you are a service technician,
Servicing:

- * TV
- * CB
- * Video
- * Antenna systems
- * Industrial electronics
- * Medical electronics

Don't be
"Just another repairman"
Be a CERTIFIED
ELECTRONICS TECHNICIAN

Write to ISCET for details
On how and where
To take the exam

ISCET - 1715 Expo Lane
Indianapolis, IN 46224
317-241-8172

The MARKETPLACE

Advertising rates in the Classified Section are 35 cents per word, each insertion, and must be accompanied by cash to insure publication.

Each initial or abbreviation counts a full word.

Minimum classified charge \$3.00.

For ads on which replies are sent to us for forwarding (blind ads), there is an additional charge of \$3.00 per insertion to cover department number, processing of replies, and mailing costs.

Classified columns are not open to advertising of any products regularly produced by manufacturers unless used and no longer owned by the manufacturer or a distributor.

BUSINESS OPPORTUNITY

TV & STEREO SALES & SERVICE: Grossed \$120,000 last year. Low rent location—heavy traffic. Ideal expansion possibilities. Asking \$17,500.00. H. J. Brown, P.O. Box 759, Anaheim, CA 92805. 5-77-1t

TV SALES & SERVICE—Established 15 yrs. Two houses, shop on corner lot. Servicing most major motels, mostly color, very good volume, drive-in service, good reputation. Inquire 305-267-9570, 509 Park Avenue, Titusville, Florida. Will show figures to interested buyers only. 5-77-1t

RCA & ZENITH SALES & SERVICE SHOP FOR SALE. Ten years old. Mountain town, 2350' elevation, 4500 population. Only shop within 35 mile radius. Retiring. Valley Electronics, Box 816, Hayfork, Calif. 96041. 5-77-3t

FOR SALE

TV & RADIO TUBES 36c EA!! Free color catalog Cornell, 4221 University, San Diego, California 92105. 8-76-1f

POCKET DIGITAL TV COLOR/BAR GENERATOR, 16 patterns. Complete plans \$4.95. Kit/wired \$39.95 up. Workshop, Box 393E8, Bethpage, N.Y. 11714 4-77-6t

SAMS PHOTOFACTS 3-1546, 80% complete & TSM SERIES. Sell individual sets or whole lot, or trade for AR, MHF series or test equipment. Write for list. Action TV & Radio, 1180 Los Altos Ave., Los Altos, CA 94022. 5-77-1t

BUILD ELECTRONIC DEVICES in your home. Get started in your spare time. Big profits. Experience not necessary. Ask for free literature telling how. Electronic Development Lab, Box 1535, Pinellas Park, Fla. 33565. 4-77-1f

TEKFAK TV SCHEMATICS, 1953-1977. Best offer. Matt Rusk, 211 SW Madison Circle, St. Petersburg, Fla. 33703. 5-77-1t

FOR SALE (CONT.)

REPLACEMENT COLOR YOKES-DEALERS ONLY Zenith 95-2501-2532-2638-2667-S-89633 etc. 16.95, Magnavox 361380-1 18.95, Sylvania, GE etc. 14.95 to 19.95. Request for price list on your Letterhead. David Sims Enterprises, Inc. 665 Jericho Turnpike, Huntington Station, N.Y. 11746. 12-76-1f

TV SHOP OUT OF BUSINESS: Selling 1300 SAMS, 2000 tubes, parts, eqpt.—Best offer. For details write: Robert Johnson, Rt. 1, Box 138A, Severn, MD 21144. (301) 674-2470. 5-77-1t

ONE MAN TV CART—YES now one man can pick up a 6-foot TV stereo consul, or any other standard TV, from the customers home into the truck and to the workbench BY HIMSELF. Professional TV, 310 South First East, Mt. Pleasant, Utah 84647. 5-77-2t

COMPLETE PICTURE TUBE REBUILDING EQUIPMENT for B&W and Color tubes. Only used one year. Cost \$5,000.00. Want \$3,000.00 for equipment and all supplies. Worth Hitchcock, Rt. #3, Birch Tree, Mo., (314) 292-3281. 5-77-1t

RADAR DETECTORS are Big Business! Dealers can buy the Long Ranger Radar Receiver with light & buzzer & cigarette lighter connector for \$62.50 each. Retail for \$89.95 to \$99.95. Distributed by Ronkel, Inc., P.O. Box 13151, Arlington, Texas, 76013. 5-77-1t

SOUND TECHNOLOGY 1000A FM Alignment Generator, Cables, Matching Transformer For Sale. Eight Months Old. JSH Laboratories, Inc., 1802 West Grant Road, #114, Tucson, Arizona 85705. (602) 623-3987. 5-77-1t

WD11 TUBES: WD11A—\$15. WD11R—\$10. 3403 Broadway, Long Beach, CA, 90803. 5-77-1t

WANTED

TUBES WANTED: Any Quantity—VT24/864. 3403 Broadway, Long Beach, CA 90803. 5-77-1t

EDUCATION-INSTRUCTION

REPAIR TV TUNERS—High Earnings; Complete Course Details, 12 Repair Tricks, Many Plans, Two Lessons, all for \$2. Refundable Frank Bocek, Box 3236 Enterprise, Redding, Calif. 96001. 8-76-1f

LATEST FCC QUESTIONS, ANSWERS, "explanations" compiled from technical schools, colleges, avionics companies across the country. \$11.00, S. Mager, Box 26151, Los Angeles, California 90026. 5-77-1t

HELP WANTED

OUTSIDE SERVICE TECHNICIAN. Paying top wages for best qualified men. Qualifications for position: Total honesty, industrious, ten or more years direct television experience, non-drinker, non-smoker, must be able to work without supervision. Present employees grossing over \$20,000.00. Send resume to American Television Service, 1032 So. State, Orem, Utah 84057. 3-77-4t

ELECTRONIC TECHNICIAN: Leading boatyard in Maine would like to engage a qualified technician to sell and service electronic equipment. We now have franchises for the best lines in radar, VHF, SSB, Ioran, sounders and sonar. We would prefer a person desiring to run his own business on our premises. Class II and radar endorsement required. Would like to talk in detail with interested party. Dept. 513, Electronic Servicing, Box 12901, Overland Park, KS 66212. 5-77-1t

advertisers' index

American Technology Corp.	9
Arrow Fastener Co., Inc.	49
B&K Div., Dynascan Corp.	22
Bussmann Mfg. Div.	
McGraw-Edison	3
Castle Electronics	63
Chemtronics	43
Charles T. Curtis	67
John Fluke Manufacturing Company, Inc.	Cover 4
Fuji-Svea Enterprises	9
Gem City Tuner	8
General Electric Company, Tube Division	11
Hickok, Instrumentation & Controls Div.	59
ISCET	67
MTI	65
Micro-Ovens, Technical Services ...	66
Mountain West Alarm Supply Co. ...	63
NESDA	54
NATESA	62
Oelrich Publications	63
PTS Electronics	Cover 2, 1
Perma Power Company	63
Pomona Electronics— Division of ITT	2
Projector-Recorder Belt Company	65
RCA Distributor & Special Products ...	12,13,20,21,34,35
Science Workshop	63
Sencore	39
Sperry Tech, Inc.	54
Sprague Products Co.	Cover 3
GTE Sylvania ECG Consumer Renewal	5
TeleMatic	55
Thordarson Meissner, Inc.	57
TransVista	62
Tuner Service Corp.	7
VIZ Manufacturing Co.	47
Winegard Company	23

REGIONAL ADVERTISING SALES OFFICES

Indianapolis, Indiana 46280
ROY HENRY
2469 E. 98th St.
Phone: (317) 846-7026

Greenlawn, New York 11740
CHUCK HORNER
P.O. Box 175
Phone: (516) 757-7863

Mountain View, California 94043
DENNIS TRIOLA
2680 Bayshore Frontage Road, Room 102
Phone: (415) 961-0378

London, W.C. 2, England
JOHN ASHCRAFT & CO.
12 Bear Street
Leicester Square
Phone: 930-0525

Badhoevedorp, Holland
JOHN ASHCRAFT & CO.
JOHN J. LUCASSEN, Mgr.
Sloterweg 303
Phone: 2968-6226

Tokyo 1, Japan
INTERNATIONAL MEDIA
REPRESENTATIVES LTD.
Shiba-Kotohiracho, Minatoku
Phone: 502-0656

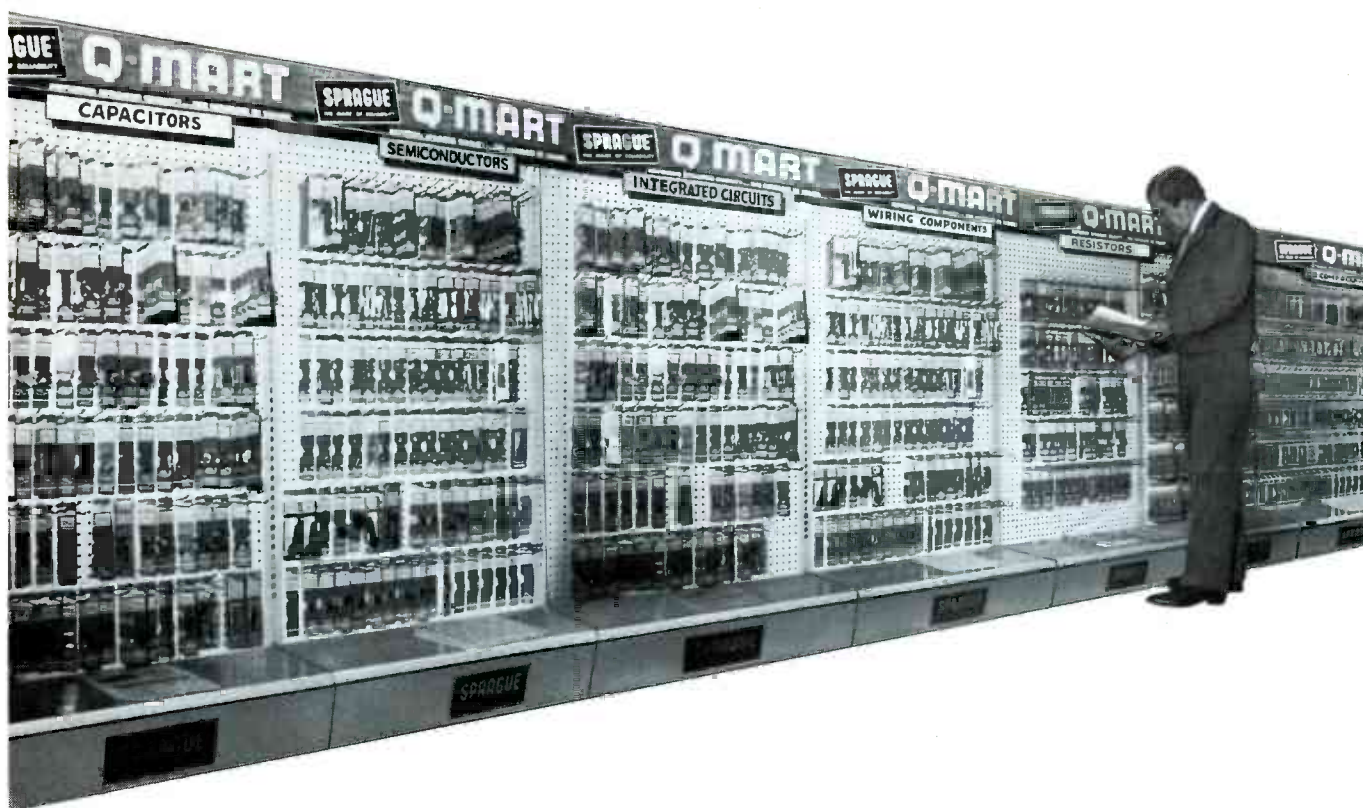

Picture of an astute service technician

Whether you're servicing TV, AM/FM radio, CB transceivers, Hi-Fi equipment, garage-door openers, or other electronic gear, it pays you to go to your nearest Sprague Q-MART distributor for replacement parts.

Sprague Q-Line components are the best, easiest-to-use, quickest-to-locate parts available to the service trade. Hundreds of Sprague Q-MARTS are located throughout the country. They're out there to keep you and your customers happy by letting you spend more time at the bench and less time in those frustrating searches for needed replacements.

On Q-MART displays you'll find the hottest, most-needed capacitors, resistors, filters, transistors, diodes, rectifiers, ICs, quartz

crystals, solid state tubes, semiconductor hardware, LED devices, alpha-numeric displays, switches, lamps, and wiring components such as solderless terminals, specialty connectors, terminal blocks, cable clamps, etc. They're all neatly packaged and marked for easy, time-saving selection.

But the best news is that the Sprague name on every package assures you of high-quality call-back-free components that help build your reputation for dependable service.

Get to know the Sprague Q-MART distributor in your area. If you're not sure who he is, write to us for the location of the Q-MART nearest you. Sprague Products Company, 71 Marshall St., North Adams, Mass. 01247.

MEMBER



AMERICA'S LARGEST MANUFACTURER OF ELECTRONIC COMPONENTS

SPRAGUE[®]

THE MARK OF RELIABILITY

65-6126

Six important questions to ask of any DMM that claims to be designed for field service.



We give you a choice of 3½ or 4½ digits, manual or autorange.

At Fluke, we've been building DMMs for a long time. We're the leader.

And if there's one thing we've learned over the years, it's that what works for the bench doesn't always work for the field.

But a lot of companies don't understand that. They'd like you to believe their DMM is perfect for field service. Just because they've put it in a different case.

Here's how to tell the difference:

1) Is the size and shape designed for the field?

How do you carry your tools? We designed the 8030A/8040A DMMs into an ideal shape after we researched the requirements of field service work. It's sized to fit in a case. And it's rugged, to take the beating field instruments must survive.



If it doesn't fit here, it's not for field service.

2) Does it have true rms ac?

Make sure you get usable accuracy. You'll need true rms ac to eliminate errors when measuring distorted waveforms. (And if you don't understand the importance of true rms, write for our bulletin on True RMS Measurement.)

3) Does it give full performance?

Just because it's a field instrument, you shouldn't sacrifice

performance. Demand five measurement functions in 26 ranges. Top specs, like our 8040A basic dc accuracy of $\pm 0.05\%$ or our 8030A basic dc accuracy of $\pm 0.1\%$. And the specifications are guaranteed for one year. Important extras, like diode test for measurement of semiconductor junctions in-circuit, high voltage protection, and self test feature. And a complete line of accessories: various battery options, and probes for measurement of rf voltages, high current ac, high voltage dc and temperature.

4) Do you have a choice of manual or autorange?

We offer two versions: the 8030A 3½ digit and the 8040A 4½ digit with autoranging. Because we know not all field service applications are alike.

5) What is the price?

A field service DMM is a tool, and should carry a practical price. Our 3½ digit 8030A is \$250.* Our 4½ digit 8040A is \$440.* Check around and you'll see how practical that is.

6) Do you trust the company that builds it?

We became the leader in DMMs for one reason only. We build digital multimeters that people trust and continue to use, year after year. We've sold hundreds of thousands of DMMs.

And every bit of that experience has gone into the 8030A and 8040A DMMs.

For data out today, dial our toll-free hotline, 800-426-0361. John Fluke Mfg. Co., Inc., P.O. Box 43210, Mountlake Terrace, WA 98043. Fluke (Nederland) B.V., P.O. Box 5053, Tilburg, The Netherlands. Phone: (013) 673-973 Telex: 52237.

*U.S. price only.

The field service DMMs for field service people.



For More Details Circle (26) on Reply Card